



Chase Doors

World's Leading Manufacturer of Specialty Doors

Chase Traffic Doors

Traffic & Specialty Door Systems



Durulite® Industrial



The Durulite Industrial Door is the toughest traffic door in the industry. It is known for its ruggedness, ease of maintenance and long service life. This versatile door is capable of filling the needs of a wide variety of applications. From the daily rigors of forklift traffic, to refrigerated applications, to USDA and washdown applications. The strength of the Durulite Industrial is due to its rotationally molded polyethylene construction. Standard tests for impact resistance indicates that rotationally molded polyethylene is 5 times more puncture resistant and 3 times more flexible than ABS material. The corrosion resistant panel is ideal for washdown applications as it has no gaps or joint seams.

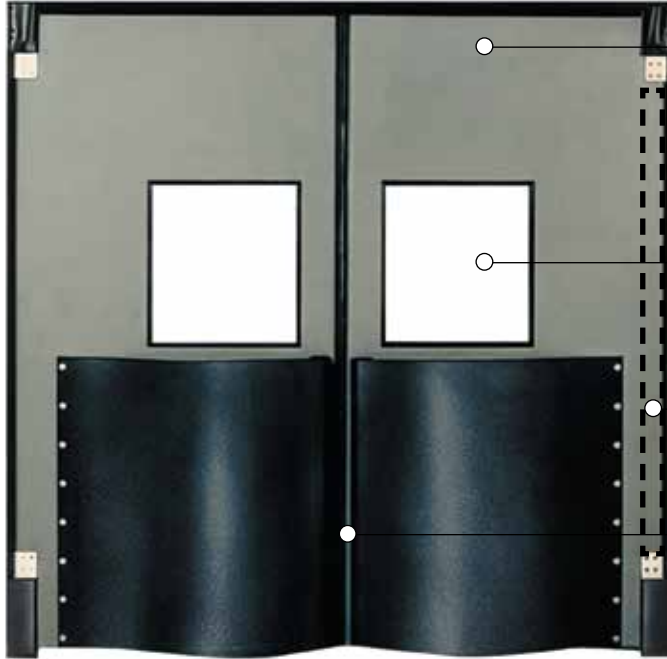

Door Panel – Lightweight, weighing only 3.5 pounds per square foot, is easy to open, operates smoothly and allows for safe passage of personnel and damage free equipment. The overall panel thickness is 1-7/8", the skin thickness is 1/4" thick and the door can be sized up to a 10' x 10'. Rotationally molded polyethylene outer skins retains its properties to -40°F.

Window – 1/8" thick polycarbonate window with black frame is recessed a minimum of 1/8" from the face of the panel to protect the window's surface from abrasion caused by passing loads.

Internal Reinforcement – The leading and back edge of the door is internally reinforced with tubular steel to strengthen the door panel.

Gasketing – USDA accepted durable gasketing is factory applied without the use of metal strips or fasteners, making it easy to replace in the field.

Durulite Industrial shown with optional teardrop bumpers

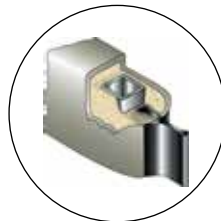
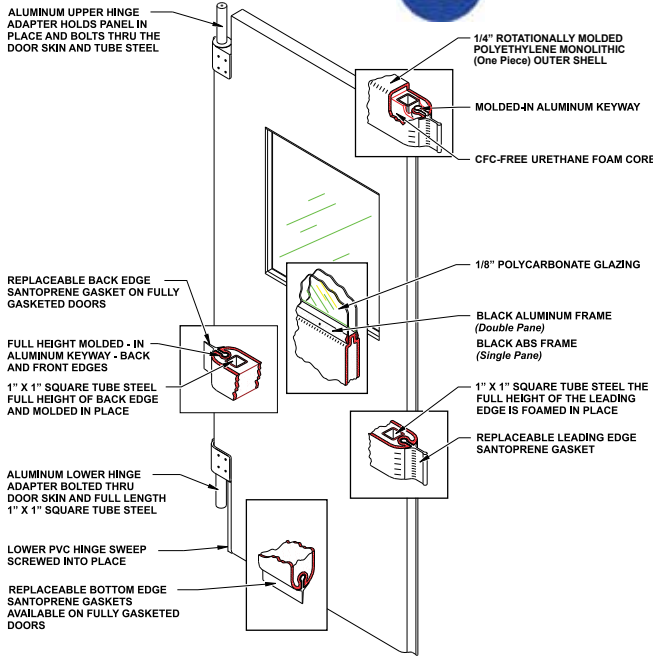

Insulated Core – The foamed-in-place CFC-free urethane core (permanently bonded to the outer surface) does not break down when impacted, provides noise control and excellent insulation with an R factor of 10.83.



Upper Hinge – Double-acting V-Cam hinging system operates smoothly and is virtually maintenance free with its permanently lubricated needle bearing roller assembly. Optional stainless steel V-Cam is available.



Bottom Hinge – For additional strength and durability the hinge is designed with pillow block constructed of zinc plated ductile iron (stainless steel is optional) with a UHMW sleeve and solid cast aluminum lower hinge adapter. Plus the lower hinge adapter has a provision for mounting an optional spring assist.

Applications	Environment	Options
<ul style="list-style-type: none"> • Food Processing • Industrial • Institutional • Pharmaceutical • Postal • Cold Storage • Warehouse 	<ul style="list-style-type: none"> • Freezer • Cooler • USDA Accepted • Personnel • Interior • Loading Dock • Washdown 	<ul style="list-style-type: none"> • 180° x 90° Hardware • Teardrop Bumpers • Impact / Kick Plates • Lower Hinge Guards • Spring Assist • Locking Devices • Window Options

See page 7 for colors and options

Durulite® Standard



Durulite Standard Doors are designed as a multi-purpose lightweight door, yet they are tough enough to take the abuse of personnel, stock carts and motorized pallet jacks. Like the Durulite Industrial, it's strength lies in its rotationally molded polyethylene construction. Standard tests for impact resistance indicates that rotationally molded polyethylene is 5 times more puncture resistant and 3 times more flexible than ABS material. The door is designed to comply with all USDA sanitation requirements and was tested and certified by NSF. The panel is corrosion resistant, making it ideal for washdown applications as it has no gaps or joint seams.

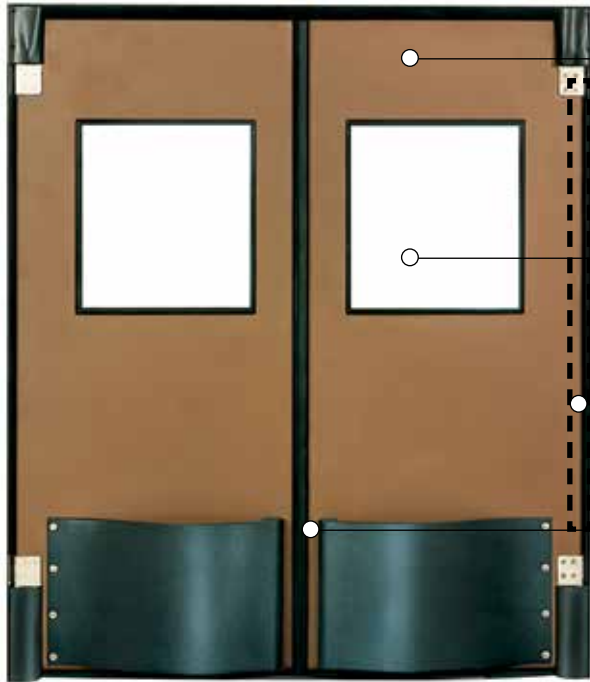

Door Panel – Lightweight, weighing only 2.5 pounds per square foot, is easy to open, operates smoothly and allows for safe passage of personnel and damage free equipment. The overall panel thickness is 1-7/8", the skin thickness is 1/8" thick and the door can be sized up to a 8' x 10'. Rotationally molded polyethylene outer skin retains its properties to -40°F.

Window – 1/8" thick polycarbonate window with black frame is recessed a minimum of 1/8" from the face of the panel to protect the window's surface from abrasion caused by passing loads.

Internal Reinforcement – The leading and back edge of the door is internally reinforced with tubular steel to ensure flatness and strengthen the door panel.

Gasketing – USDA accepted durable gasketing is factory applied without the use of metal strips or fasteners, making it easy to replace in the field.

Durulite Standard shown with optional teardrop bumpers

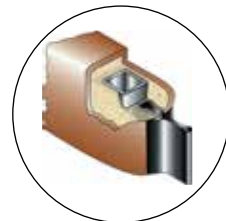
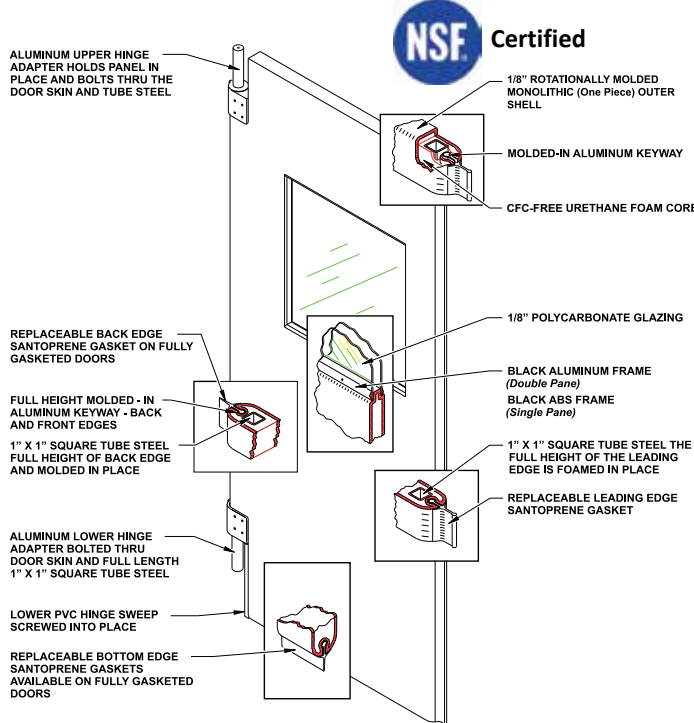

Insulated Core – The foamed-in-place CFC-free urethane core (permanently bonded to the outer surface) does not break down when impacted, provides noise control and provides excellent insulation with an R factor of 10.83.



Upper Hinge – Double-acting V-Cam hinging system operates smoothly and is virtually maintenance free with its permanently lubricated needle bearing roller assembly. Optional stainless steel V-Cam is available.



Bottom Hinge – For additional strength and durability the hinge is designed with pillow block constructed of zinc plated ductile iron (stainless steel is optional) with a UHMW sleeve and solid cast aluminum lower hinge adapter. Plus the lower hinge adapter has a provision for mounting an optional spring assist.

Applications	Environment	Options
<ul style="list-style-type: none"> • Food Processing • Institutional • Pharmaceutical • Retail • Supermarket • Warehouse 	<ul style="list-style-type: none"> • Freezer • Cooler • USDA Accepted • Personnel • Interior • Loading Dock • Washdown 	<ul style="list-style-type: none"> • Lower Hinge Guards • Window Options • Impact/Kick Plates • Teardrop Bumpers • 180° x 90° Hardware • Spring Assist • Locking Devices

See page 7 for colors and options

Durulite® Retailer XHD



Constructed with rotationally molded polyethylene, impact absorbing Non-CFC urethane foam core, and full height aluminum back spine, the Durulite Retailer XHD is exceptionally durable in high volume retail establishments. The Retailer XHD corrosion resistant panel is ideal for high moisture or regular washdown applications. The door panel has no gaps, joints or seams, and offers corrosion resistant hardware including composite V-Cams, stainless steel rollers and stainless steel lower hinge guards as standard components. Plus the Retailer XHD is tough enough to withstand the abuse of personnel, carts, manual and motorized pallet jacks and occasional low speed forklift traffic. This heavy duty door is design to comply with all USDA sanitation requirements.

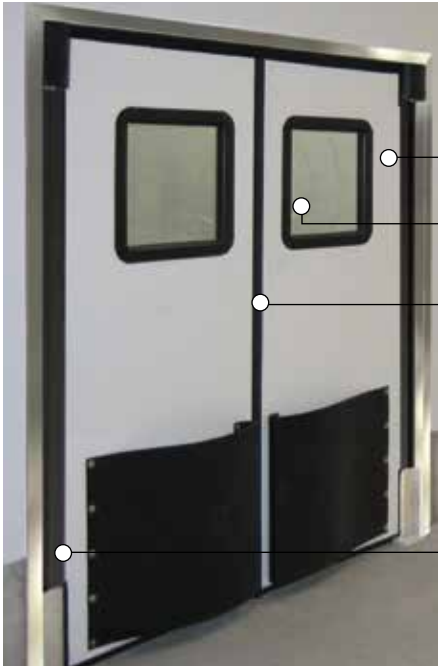

Door Panel – Durulite doors are known for their long-term value and durability. Overall panel thickness is 1-1/2” and rotationally molded polyethylene skin is 1/8” thick. The door panels are foamed-in-place with Non-CFC urethane core to ensure a tenacious bond between the core and the outer skin.

Window – Large polycarbonate windows are virtually scratch resistant.

Gasketing – Replaceable perimeter edge gasketing is used to reduce energy flow between environments. The door comes standard with gasket along the leading, back and bottom edges.

Lower Hinge Guard & Back Spine – Heavy duty lower hinge guard assembly protects the door panel from impact while acting as a positive hinge mount. Standard stainless steel construction eliminates corrosion problems. A heavy duty aluminum back spine with powder coat finish adds additional strength and ensures panel rigidity.

Durulite Retailer XHD Shown with Optional Bumpers

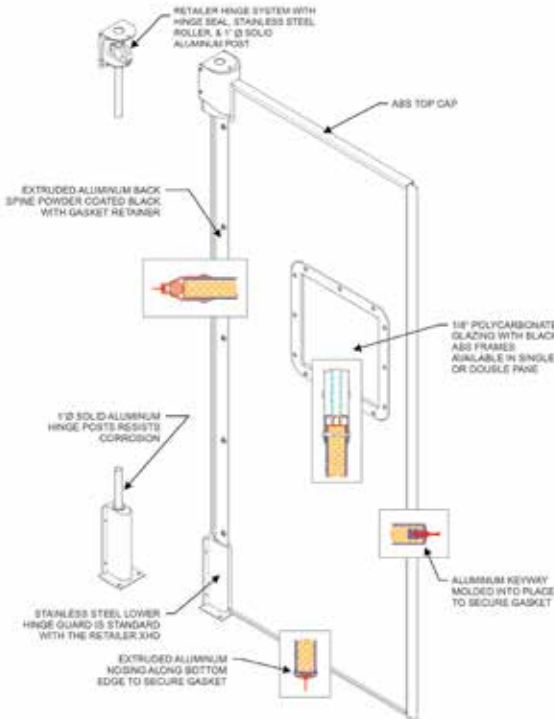

Insulated Core – High density, CFC-free urethane core is foamed-in-place to insure a tenacious bond between the core and outer skin, providing sound abatement and excellent thermal separation with an R factor of 9.86.



Upper Hinge & Roller Assembly – Patented composite V-Cam hinge system can travel 120° in each direction and is mounted to a stainless steel base plate. The upper aluminum roller assembly has stainless steel bearings for years of service with minimal maintenance.

Applications	Environment	Options
<ul style="list-style-type: none"> • Food Processing • Institutional • Retail • Supermarket • Pharmaceutical 	<ul style="list-style-type: none"> • Cooler • USDA Accepted • Personnel • Interior • Washdown 	<ul style="list-style-type: none"> • Window Options • Impact/Kick Plates • Teardrop Bumpers • Cart Guards • SlideTrac Bumpers™

See page 7 for colors and options

Durulite® Retailer



Durulite Retailer Doors are constructed with rotationally molded polyethylene, making them extremely durable and capable of withstanding the wear and tear associated with sales-to-back room and walk-in cooler openings in high volume retail establishments. Known for their long-term value, they are ideal for use in supermarkets, retail establishments, institutions, restaurants and food service operations as they provide a visual separation, sound barrier and thermal separation. The door is designed to comply with all USDA sanitation requirements and was tested and certified by NSF.



Door Panel – Lightweight, opens easily and closes every time. Overall panel thickness is 1-1/2”, skin thickness is 1/8” and the door can be sized up to 8’ x 10’. Rotationally molded polyethylene outer skin retains its properties to -40°F.

Window – Large polycarbonate windows are virtually scratch resistant.

Gasketing – Replaceable perimeter edge gasketing is used to reduce energy flow between environments. The door comes standard with gasket along the leading, back and bottom edges. Partially gasketed doors are available.

Internal Reinforcement – A 1” diameter hinge post is molded in the door and runs the full length of the panel. The hinge post sets into the jamb guard for structural stability and strength. The leading edge is reinforced with an aluminum extrusion adding additional structural support.

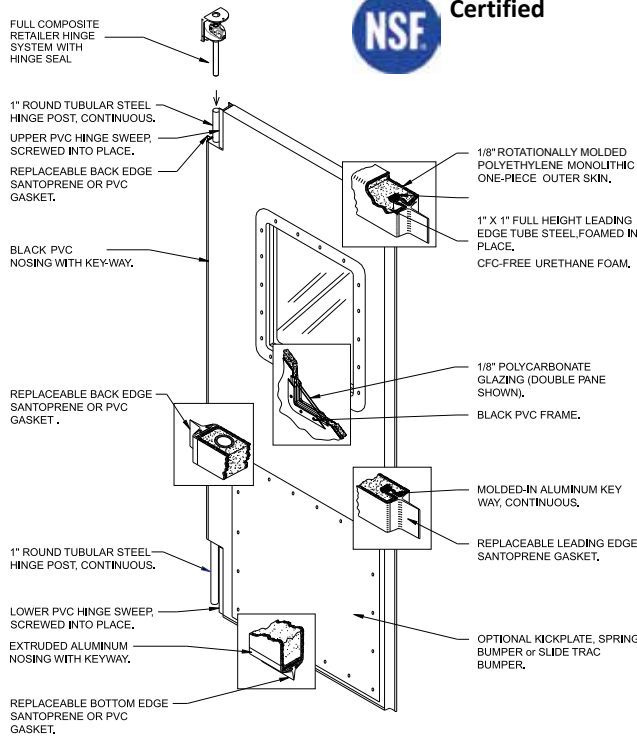

Durulite Retailer Shown with Optional Impact Plates



Insulated Core – High density, CFC-free urethane core is foamed-in-place to insure a tenacious bond between the core and outer skin, providing sound abatement and excellent thermal separation with an R factor of 9.86.



Upper Hinge – Patented fully composite V-Cam roller assembly resists corrosion and rust and can travel up to 120° in each direction.

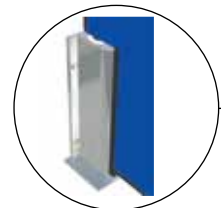

Lower Hinge Assembly – The lower hinge assembly holds the lower hinge post in position, preventing horizontal movement of the door. It also serves as a lower hinge guard, protecting the lower hinge post from impact damage.

See page 7 for colors and options

Applications	Environment	Options
<ul style="list-style-type: none"> • Food Processing • Institutional • Retail • Supermarket • Food Service 	<ul style="list-style-type: none"> • Cooler • USDA Accepted • Personnel • Interior 	<ul style="list-style-type: none"> • Window Options • Impact/Kick Plates • Teardrop Bumpers • Cart Guards • SlideTrac Bumpers™

Durulite® Retailer R25



The Retailer R25 Insulated Impact Traffic Door is your solution to meeting the requirements of the 2007 Energy Independence and Security Act (EISA). The R25 utilizes time proven rotational molding technology and urethane foamed-in-place insulation to meet the insulation requirements set forth in the EISA Energy Bill. Rotationally molded panel design offers exceptional durability in a traffic door along with lightweight construction. Door panels are impervious to moisture penetration or panel separation.

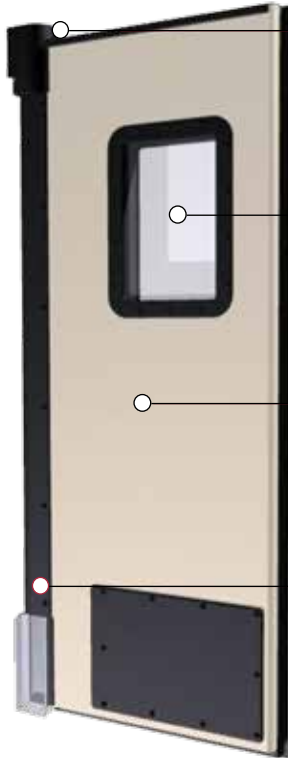

Self Closing Door System – The Retailer R25 offers comparable insulation to latching cold storage doors, while reducing air infiltration. The door allows unimpeded passage, and closes immediately once the load is through the opening. Traffic doors also enhance productivity, offering additional cost savings over traditional cold storage doors.

Window – Triple pane large polycarbonate vision panels are standard and are available in four sizes.

Gasketing – Replaceable perimeter edge gasketing is provided on the perimeter of the door panel to reduce air infiltration.

Door Panel – Rotationally molded panel design offers exceptional durability in a traffic door along with lightweight construction. Door panels are impervious to moisture penetration or panel separation. Constructed with an 1/8" thick outer shell of high-density rotationally molded polyethylene and a Non-CFC urethane foam core. The panel can retain its properties to -40°F. The overall thickness of the panel is 3-3/4", making it lightweight and easy to open.

Back Spine – Full height backspine insures panel rigidity.

Durulite Retailer R25 Shown with Optional Impact Plates

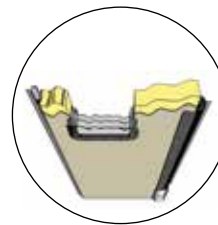

CFC-free Urethane Core – Foamed-in-place urethane insulation provides 30% to 40% greater insulation than styrene insulation. Panel durability is also much greater than doors that are glued and riveted together.



Hinge – Time proven Durulite Retailer double acting V-Cam hinge system operates smoothly and is virtually maintenance free with its permanently lubricated needle bearing roller assembly.

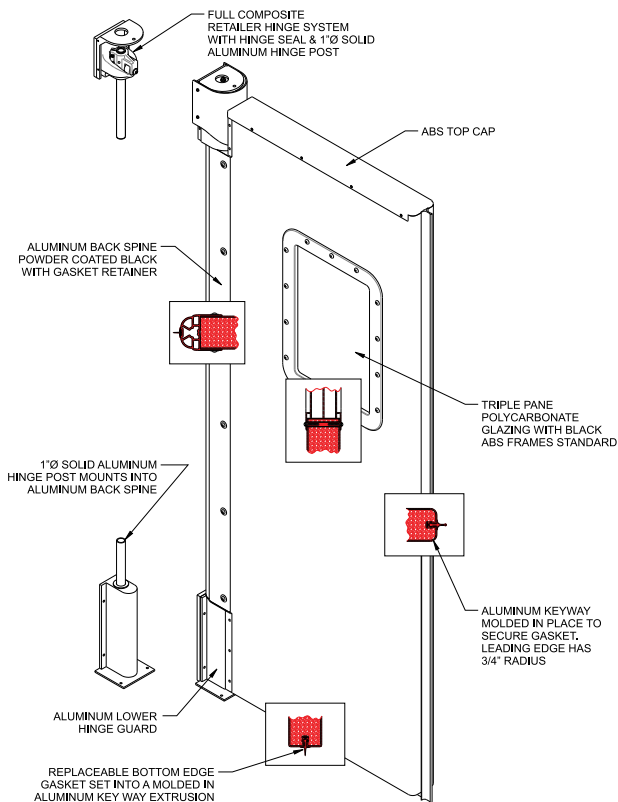

Applications	Environment	Options
<ul style="list-style-type: none"> • Food Processing • Institutional • Retail • Supermarket • Warehouse 	<ul style="list-style-type: none"> • Freezer • Cooler • USDA Accepted • Personnel • Interior 	<ul style="list-style-type: none"> • Window Options • Impact / Kick Plates • Teardrop Bumpers • Cart Guards • SlideTrac Bumpers™

See page 7 for colors and options

Durulite® Options

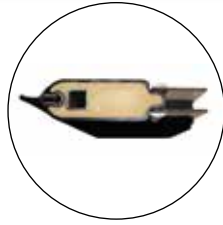

Durulite Industrial & Standard Double-pane windows – for use when temperature differential between rooms exceeds 30°F.



Limiting Posts – use for protecting and extending the life of any double-acting traffic door. Available in heights of 42” or 19”.

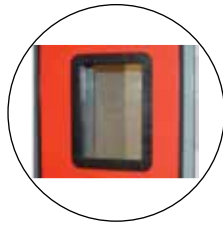

Durulite Retailer Double-pane window – for use when temperature differential between rooms exceeds 30°F. **Triple pane windows** are standard on R25. ADA windows are available for all Retailer Doors.



Double locking device (lock not included)

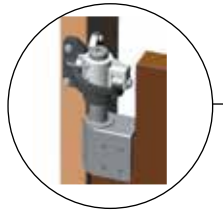

180° x 90° door hinge system – for use when vehicles must make extremely tight turns after passing through the door. The system includes the door hinges, a spring assist, and a lower hinge guard.

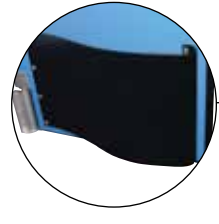

Rotationally molded polyethylene Tear Drop Bumpers with 3” or 4” projection in heights of 12”, 18”, 24”, 36”, 38” and 42” in various colors.

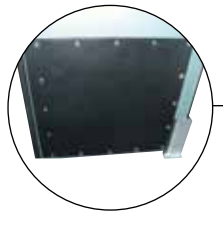

Surface mounted kickplates of high impact polyethylene or stainless steel.



Roto-molded polyethylene “D” shape Universal SlideTrac Bumper™ has a 4-1/2” projection and a slide lock rail system allowing for easy bumper replacement. Available in the colors shown below.

Window Viewing Area

Each window is 1/8” polycarbonate set in a black frame. All view windows are factory installed and sealed. The exposed surface of the window is recessed a minimum of 1/8” from the face of the door to protect the surface from abrasion caused by passing loads. The viewing area exceeds the 200 sq. in. UBC requirements. ADA sizes are available.

Window sizes are as follows for Durulite Industrial & Durulite Standard:

24” and 27” panel	10 1/2” x 22 1/2”
30” panel	14 1/2” x 22 1/2”
32” panel	16 1/2” x 22 1/2”
34” panel	18 1/2” x 22 1/2”
36”, 39 1/2”, 42”, 48” panel	20 1/2” x 22 1/2”
54” and 60” panel	22 1/2” x 22 1/2”

Window sizes are as follows for Durulite Retailer & XHD:

24”, 27” and 30” panel	12” x 18” and 12” x 30”
32” and 34” panel	12” x 18”, 16” x 16” 12” x 30”, and 16” x 30”
36”, 42” and 48” panel	12” x 18”, 16” x 16”, 17” x 23” 12” x 30”, 16” x 30” and 20” x 30”

A 12” x 18” window is standard for panels 24” and 30” wide. A 16” x 16” window is standard for panel 32”, 34”, 36” 42” and 48” wide.

Additional Product Options

- Hold open device
- Wall mounted door stops
- Push plates and pull handles
- Lower hinge guards
- Flexible top seals for partially gasketed doors
- Spring assisted hinges

Colors Available for Durulite Doors

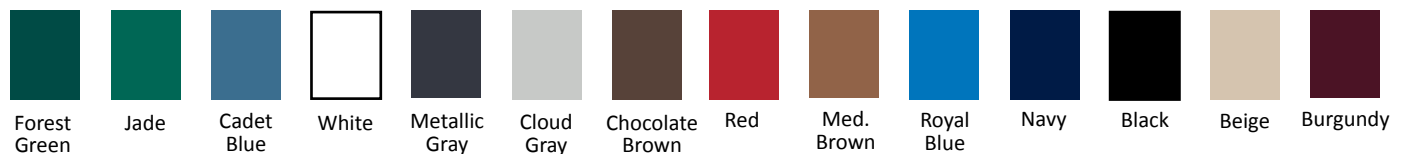

Color shown may differ slightly from actual color. Consult factory for exact color match.

Durulite® Series 200



Chase Security Doors are specifically designed and manufactured to be tough and dependable. They are strong enough to withstand punishing personnel-ridden vehicle traffic yet lightweight enough to open easily, operate smoothly, and allow for damage free, safe passage for personnel and equipment. All Chase Security Doors have been tested by the United States Postal Service and meet RE-5 security guidelines.



Additional Security – Upper and lower cane bolts, 2” chain or cable lock sleeves, and tamper proof fasteners are used for additional security.

Window – Double glazed 1/8” thick polycarbonate recessed vision panels with three security bars spaced on 7” centers.

Internal Reinforcement – The leading and back edge of the door is internally reinforced with tubular steel to ensure flatness and strengthen the door panel.

Door Panel – Patented, one-piece rotationally molded construction with 1/4” thick rotationally molded polyethylene outer skin, offers the lightest weight per panel of any USPS approved traffic door. This door offers extraordinary impact resistance and retains its properties to -40°F.

Gasketing – Full perimeter gasketing provides thermal separation and is factory applied without the use of metal strips or fasteners, making it easy to replace in the field.



Insulated Core – The foamed-in-place CFC-free urethane core (permanently bonded to the outer surface) does not break down when impacted, provides sound abatement, and excellent thermal separation with an R factor of 10.83.



Upper Hinge – Double-acting V-Cam hinging system operates smoothly and is virtually maintenance free with its permanently lubricated needle bearing roller assembly. Optional stainless steel hinge is available.



Bottom Hinge – For additional strength and durability the hinge is designed with pillow block constructed of zinc plated ductile iron (stainless steel is optional) with a UHMW sleeve and solid cast aluminum lower hinge adapter.

Proline Model 600-SEC



Additional Security – Upper and lower cane bolts, 2” chain or cable lock sleeves, and tamper proof fasteners are used for additional security.

Window and Frames – Double pane windows include three security bars spaced on 7” centers making them virtually theft proof.

Door Panel – Proline doors can be custom manufactured to fit virtually any opening size. The panel’s outer surface is available with stainless steel, galvanized, aluminum or different color ABS face sheets. The core is constructed with a combination of wood and insulated foam.

Steel Spine – Steel spine reinforces the edge of the door against heavy impacts.

Gasketing – Full perimeter replaceable bulb gaskets are built into the ProLoc™ edge to stand up to heavy traffic while providing a positive seal for thermal separation. Partially gasketed doors are optional.

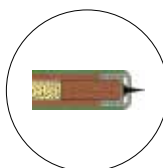

Patented ProLoc™ Edge System – Chemically bonds to the face sheets providing a positive seal and preventing moisture or contaminants from entering the door panel.



Upper Hinge – Patented V-Cam hinging system has a 250° hinge that swings 125° in each direction, wide enough to allow the entire door and bumper to completely clear the opening.



Lower Hinge Guard – 9” high lower hinge guard protects the jamb and lower hinge from passing loads.

See page 7 & 11 for colors and options

Proline 300 & 400



Proline 300 and 400 Doors are available in both solid core and insulated models. They are designed for strength and durability in tough, abusive applications. They provide visual separation, sound attenuation and thermal separation. The doors can be manufactured to fit virtually any size opening. The door is designed to comply with all USDA sanitation requirements. Surface coverings available in full height high pressure laminates, ABS impact resistant plastic, FRP, stainless steel, galvanized steel or aluminum.



Internal Reinforcement – Integrated tubular steel reinforcement from the hinge to the frame assures extra strength and durability.

Door Panel – The doors are available insulated or non-insulated with a wood core. The core of the insulated doors are 1-1/2” thick with a combination of wood and foam and are considered heavy-duty. The non-insulated wood core doors are constructed with durable 3/4” thick wood and are considered medium duty.

Steel Spine – Steel spine reinforces the edge of the door against heavy impacts, standard on Proline doors over 36” wide, optional on doors under or equal to 36” wide. Recommended for heavy-duty applications.

Gasketing – Full perimeter replaceable bulb gaskets are built into the ProLoc™ edge to stand up to heavy traffic while providing a positive seal for thermal separation. Partially gasketed doors are optional.

Proline 300 shown with optional teardrop bumpers

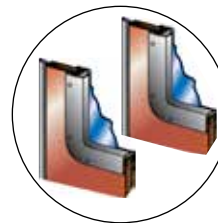
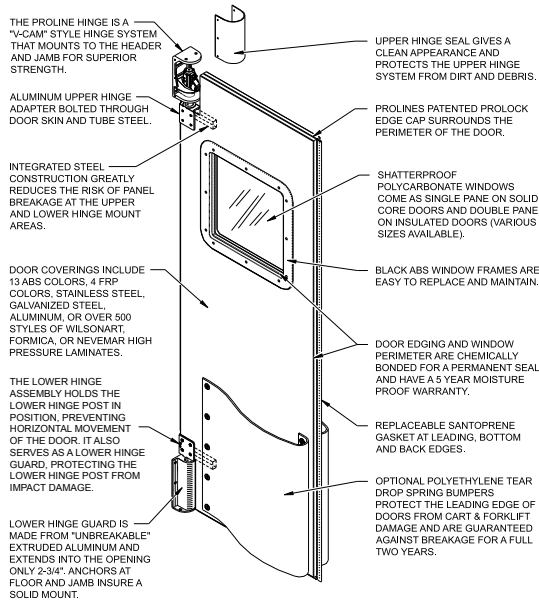

Windows & Frames – ABS window frames are chemically bonded for a permanent seal that stands up to repeated washdowns. Single pane 1/8” thick polycarbonate windows are used in the wood core doors, double pane windows are used in insulated doors.



Upper Hinge – Patented fully composite V-Cam roller assembly resists corrosion and rust and can travel up to 120° in each direction.

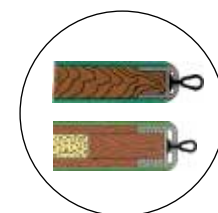

Patented ProLoc™ Edge System – Chemically bonds to the face sheets providing a positive seal and preventing moisture or contaminants from entering the door panel.

Applications	Environment	Options
<ul style="list-style-type: none"> • Industrial • Institutional • Postal • Food Service • Retail • Supermarket • Warehouse 	<ul style="list-style-type: none"> • Cooler • USDA Accepted • Personnel • Interior • Loading Dock 	<ul style="list-style-type: none"> • Lower Hinge Guards • Window Options • Impact/Kick Plates • Teardrop Bumpers • Cart Guards

See page 11 for colors and options

Chase SC 3000 Series



Chase SC 3000 Series Solid Core Doors allow you to create your own personalized look with a virtually unlimited selection of high pressure laminates, stainless steel and .032 thick aluminum. These doors provide durability with aesthetic appeal. Café style door with gate hinge also available.

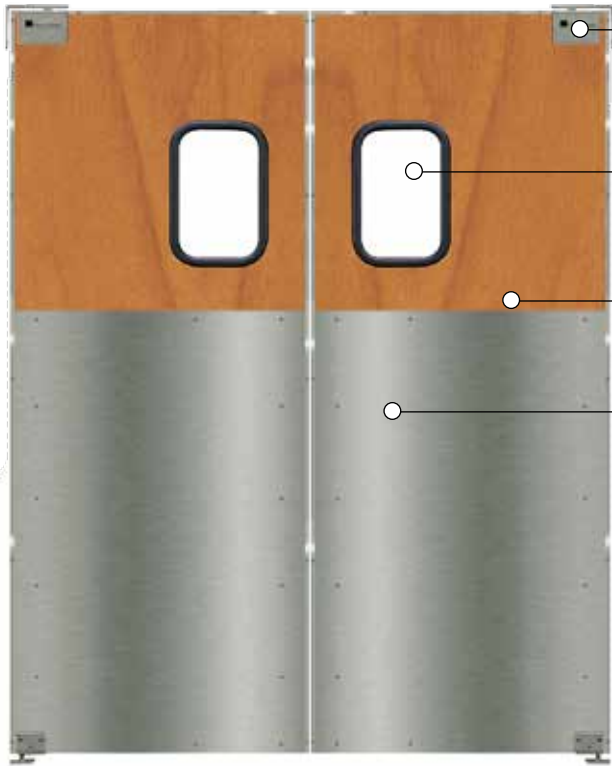

Hinge – Proven hinge system mounts to the jamb with offset cam system and hardened rollers, for years of service with minimal maintenance. Removable black hinge covers are standard and stainless steel are optional.

Window & Frames – Each window is 1/4" polycarbonate with either a vacuum formed frame or gasket. All windows are factory installed. 9" x 14" is standard, additional sizes are available.

Door Panel – The doors are constructed with a 3/4" 7-ply plywood for structural integrity.

Impact Plates – Stainless steel impact plates, standard on the 3002 model, are screwed to both sides of the door's surface.

Model SC 3002 shown with optional stainless steel hinge covers.

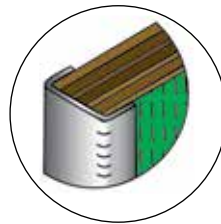
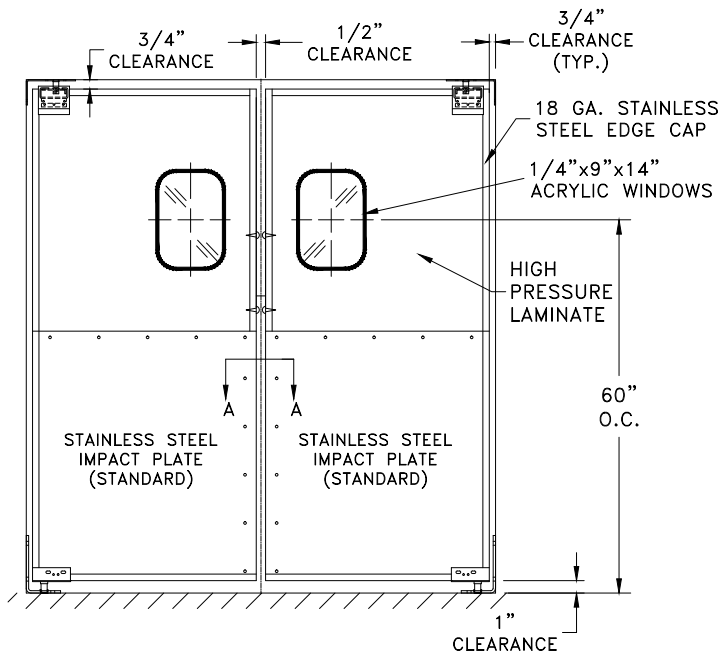

Edge Capping – Standard 18 gauge stainless steel edge capping presents a clean, finished appearance and extra edge protection.

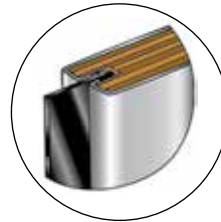

Gasketing – Optional perimeter gasketing provides a positive seal for thermal and visual separation.

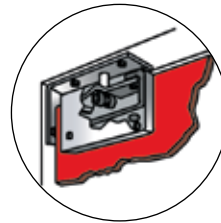

E Hinge – Classic "E" hinge has a removable cover for easy maintenance.

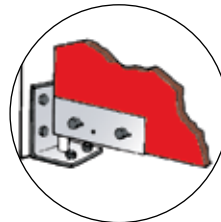

Lower Hinge – Standard heavy-duty bottom hinge pin stabilizes the panel in the frame.

Applications	Environment	Options
<ul style="list-style-type: none"> • Restaurant • Retail • Supermarket • Institutional • Food Service 	<ul style="list-style-type: none"> • USDA Accepted • Personnel • Interior 	<ul style="list-style-type: none"> • Lower Hinge Guards • Window Options • Impact/Kick Plates • Teardrop Bumpers • Cart Guards • Gasketing • Surface Mounted Locks

See page 11 for colors and options

Proline & SC 3000 Options

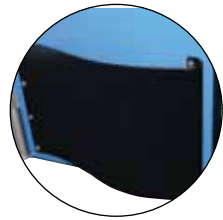

Rotatorially molded polyethylene impact bumpers provide spring action, impact absorption, and protects the door surface from heavy traffic loads – recommended for high traffic or heavy motorized traffic applications.

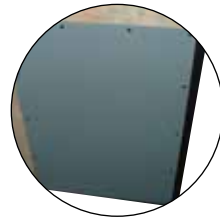

Impact plates are available in stainless steel, galvanized steel, ABS plastic or Kydex®.

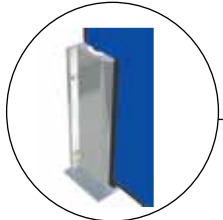

Lower Hinge Assembly – The lower hinge assembly holds the lower hinge post in position, preventing horizontal movement of the door. It also serves as a lower hinge guard, protecting the lower hinge post from impact damage.

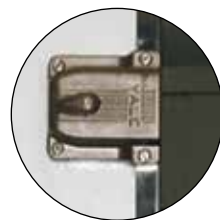

Surface mounted locks are available for single panel Chase SC 3000 Series Doors.

Proline Window Options

Each window is 1/4" polycarbonate with a vacuum formed frame. All windows are factory installed.

- Proline window sizes are as follows:
- 10" x 16" - Standard for a 24" and 30" panel
 - 16" x 16" - Standard for a 36" or larger panel
 - 10" x 30" - Available for a 24" and 30" panel
 - 12" x 18" - Panel must be 36" or larger
 - 17" x 23" - Panel must be 36" or larger
 - 23" x 23" - Panel must be 36" or larger

Chase Window Options

Each window is 1/4" polycarbonate with either a vacuum formed frame or gasket. All windows are factory installed. When selecting a window option, please keep in mind that the panel must be wider than the window by 11". Consult factory for custom shape or sizes.

- Chase window sizes are as follows:
- | | |
|---------------------|-----------|
| 9" x 14" - Standard | 30" x 18" |
| 14" x 16" | 18" x 30" |
| 20" x 15" | 6" x 20" |
| 15" x 20" | 16" x 16" |

Additional Product Options

- Gate/café style hinges
- PVC or extruded aluminum bumper strips
- Hold open device
- Push plates and pull handles

Colors Available for Proline Doors

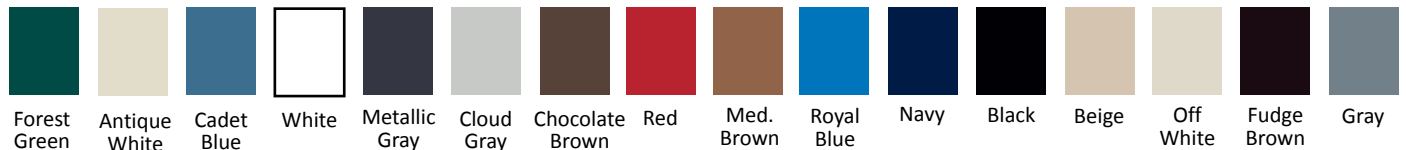

Colors Available for SC3002 & SD2002



Color shown may differ slightly from actual color. Consult factory for exact color match. Additional colors are available, but will affect lead time and price.



Chase NW 3011

The Chase NW 3011 has been engineered to cost effectively enhance traffic door functionality. Designed for easy two-way swing, this lightweight door opens manually with minimal resistance and gently closes by gravity. This door is an exceptional value for a variety of applications including restaurants, department stores and similar food service and specialty retail applications. Cafe Style doors are also available.

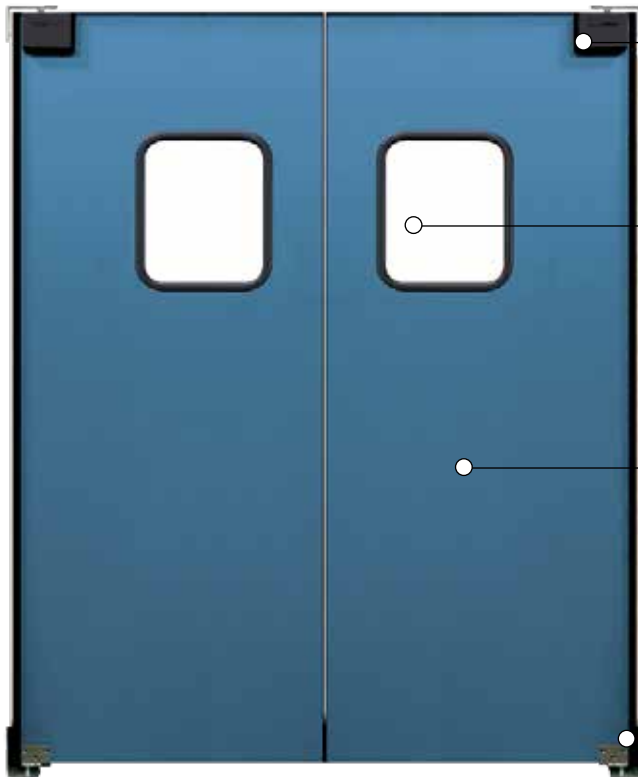

Hinge - Proven hinge system mounts to the jamb with offset cam system and hardened rollers, for years of service with minimal maintenance.

Large Window - Standard vision panels are 14" x 16" acrylic set in gasket molding, centered 60" from the floor. Additional sizes are available.

Door Panel - The simple and attractive door panel contains no wood or organic material. Constructed with textured ABS face sheets and a polymer honeycomb core.

Edge Capping - Steel back channel provides extra edge protection and is powder coated black for a clean, finished appearance.

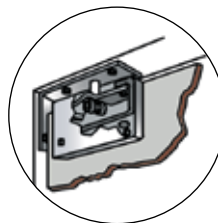
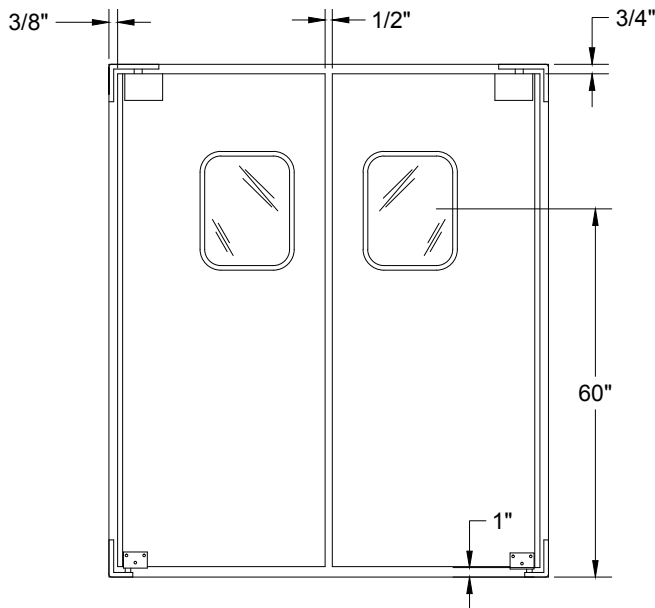

Upper Hinge - Classic stainless steel "E" hinge has a removable black cover for easy maintenance.

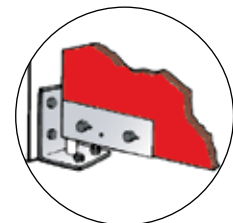

Lower Hinge - Standard heavy-duty bottom hinge pin stabilizes the panel in the frame.

Colors Available for Chase NW 3011 Doors

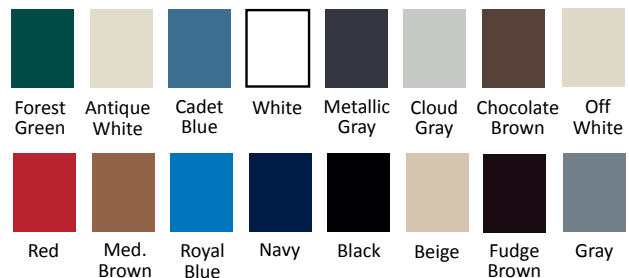

Color shown may differ from actual color. Consult factory for exact color match.

Applications	Environment	Options
<ul style="list-style-type: none"> • Restaurants • Retail Stores • Supermarkets • Convenience Stores • Institutional 	<ul style="list-style-type: none"> • USDA Accepted • Personnel • Interior 	<ul style="list-style-type: none"> • Windows • Kickplates



Chase XLP 5000 Series

The revolutionary new Chase XLP 5000 double acting traffic door offers a contemporary “designer style” look with a 3 dimensional surface. Integrated “baseball bat” bumpers above and below the window add built-in protection against abusive traffic. The XLP 5000 improves productivity by getting people and product through the door even faster. The door is designed to compliment today’s more vibrant store décor, open and close faster and easier, be safer to use, simple to install, easy to maintain and available at a price less than traditional products.



Hinge – The Ultra Soft Touch assisted gravity hinge system (patent pending) is “hidden” in the back spine. There are no unattractive upper panel cutouts or large corner hinge components visible. The hinge system is pre-installed, saving installation time and money.

Window & Frames – To aid in safety the door comes standard with a large, 7” x 30” oblong ADA and OSHA compliant window, which provides better visibility and reduces accidents. To compliment the door a black ABS frame is used.

Door Panel – Exclusive “hollow core” panel is thin, flexible and lightweight. The shell uses a recyclable polyethylene plastic and has a minimum wall thickness of 1/8”, overall panel thickness varies from 1” to 2” due to its 3 dimensional surface of “baseball bat” bumpers below and above the window.

Back Edge Spine – For added strength and durability, the entire length of the panel is reinforced at the back with a one piece continuous extruded aluminum with flanges that wrap the door panel. The spine is powder coated gray or black.

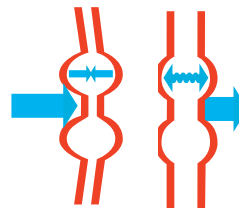

SpringFX Technology – The XLP 5000 improves productivity by getting people and product through the door even faster than before by turning impact energy into opening speed with SpringFX technology. As the door absorbs an impact, the lightweight “hollow core” plastic door and bumpers will compress back to its normal shape accelerating the opening speed.

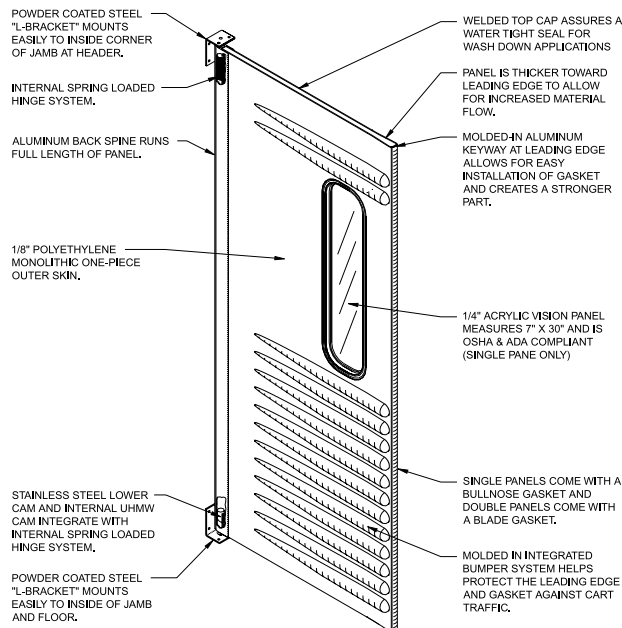

Hidden Hinge System – The full length back spine contains the in-line cam, coil spring gravity assist hinge system that helps the door close fast. The hinge allows for an extra wide swing, reducing damage from “wrapping” the jamb. Panel centering adjustment is located at the bottom of the door.

Colors Available for XLP 5000

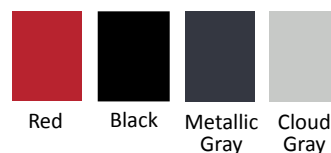

Color shown may differ from actual color. Consult factory for exact color match.

Applications	Environment	Options
<ul style="list-style-type: none"> • Institutional • Restaurant • Retail • Supermarket • Food Service 	<ul style="list-style-type: none"> • USDA Accepted • Personnel • Interior 	<ul style="list-style-type: none"> • Back Spine in Gray or Black • 9” Lower Hinge Guards



Chase SRP 5000 Series

Chase SRP 5000 Service Doors are ideal for use in retail stores between stock rooms and sales floor and any other application where an attractive, lightweight, durable and affordable traffic door is a consideration. This door is easy to install and can be maintained with minimal effort. Café style door is also available.

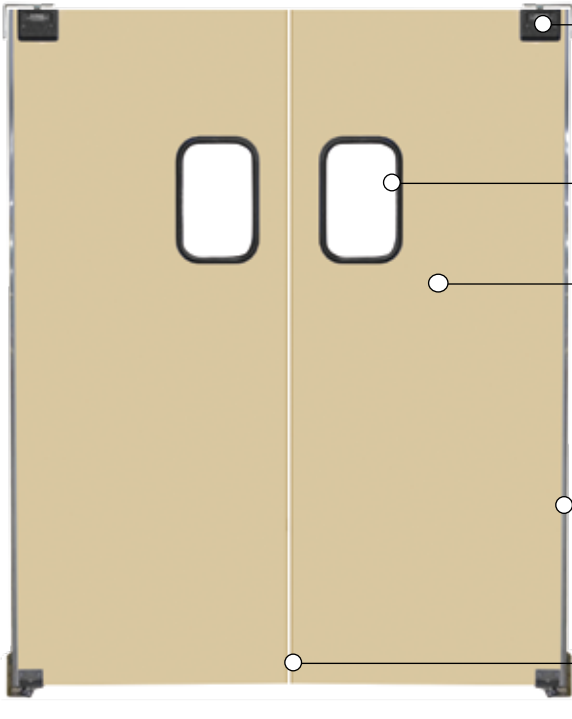

Hinge – Proven hinge system mounts to the jamb with offset cam system and hardened rollers, for years of service with minimal maintenance.

Window & Frames – Windows are 9" x 14" acrylic set in black rubber molding.

Door Panel – Lightweight, durable doors are constructed of 1/2" thick USDA accepted stress relieved high-density polyethylene. Door panels are textured and have the color throughout, hiding normal dents and scratches. HDPE material meets industry standards maximum allowable panel deflection of a 1/4" per 36".

Edge Capping - Stainless steel back channel presents a clean, finished appearance and provides extra edge protection.

Leading Edge – Leading panel edge is beveled for safety.

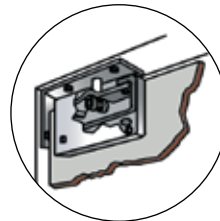
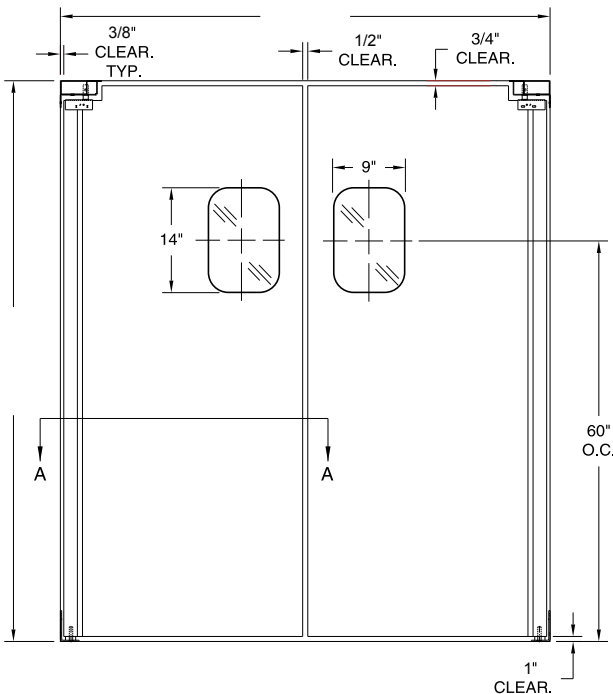

Upper Hinge – Classic stainless steel "E" hinge has a removable black cover for easy maintenance.

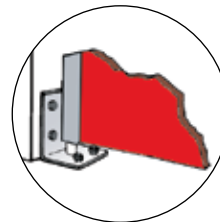

Bottom Hinge – Heavy-duty bottom hinge pin stabilizes the panel in the frame.

Colors Available for SRP 5000

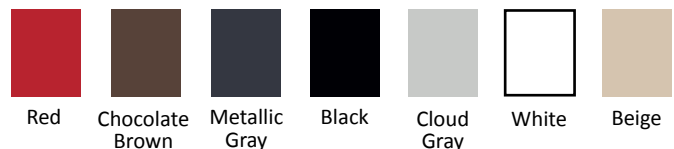

Color shown may differ from actual color. Consult factory for exact color match.

Applications	Environment	Options
<ul style="list-style-type: none"> • Institutional • Restaurant • Retail • Supermarket • Food Service 	<ul style="list-style-type: none"> • USDA Accepted • Personnel • Interior 	<ul style="list-style-type: none"> • Window Options • Impact/Kick Plates • Teardrop Bumpers



Chase ABS 5000 Series

Lightweight, Chase ABS 5000 Service Doors open manually with minimal resistance and gently close by gravity. They provide exceptional value for a variety of applications including retail, supermarkets, restaurants and any other light to medium duty applications where durability, aesthetic appeal and low costs are considerations. Café style door with gate hinge also available.



Hinge – Proven hinge system mounts to the jamb with offset cam system and hardened rollers, for years of service with minimal maintenance.

Window & Frames – Standard vision panels are 14" x 16" scratch resistant polycarbonate set in black rubber gasket for a clean, low profile look and centered 60" from the floor.

Door Panel – Lightweight, durable doors are constructed of 1/4" textured ABS plastic and resist dents, gouges and abrasions during normal use.

Back Edge Spine – The entire length of the panel is reinforced at the back with 2 layers of 7" wide x 1/4" thick ABS material, allowing for superior impact resistance and virtually eliminating broken spines.

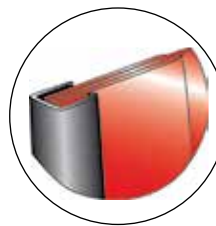
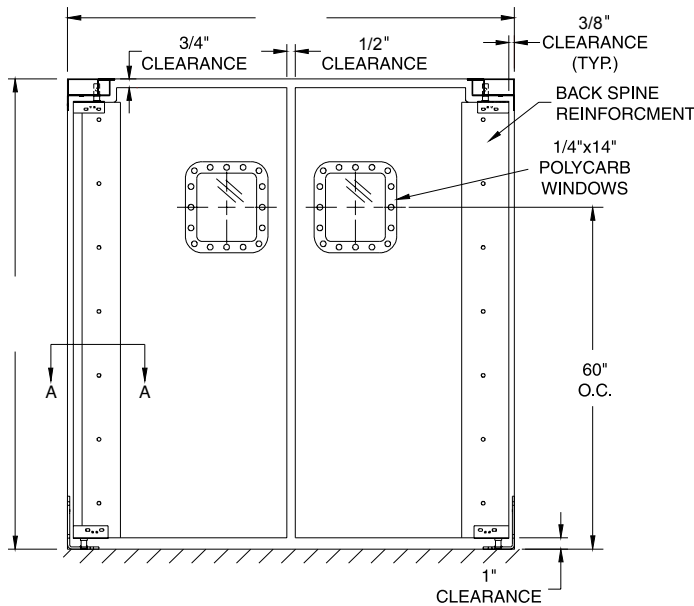

Back Spine – Heavy-duty stainless steel back channel stiffens the spine for added strength and stability.

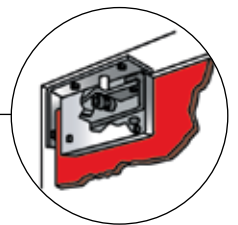

E Hinge – Classic "E" hinge has a removable black cover for easy maintenance.

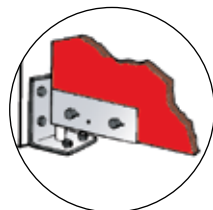

Bottom Hinge – Heavy-duty bottom hinge pin stabilizes the panel in the frame.

Colors Available for ABS 5000

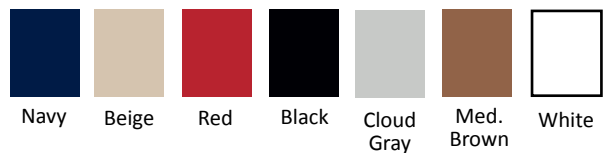

Color shown may differ from actual color. Consult factory for exact color match.

Applications	Environment	Options
<ul style="list-style-type: none"> • Institutional • Restaurant • Retail • Supermarket 	<ul style="list-style-type: none"> • USDA Accepted • Personnel • Interior 	<ul style="list-style-type: none"> • Lower Hinge Guards • Impact/Kick Plates • Cart Guards • Various window sizes

EcoSwing[®]



Chase is opening doors to a greener world while making a positive impact on the environment with a door that will help contribute to LEED[®] credits. The EcoSwing[™] might look like our SRP5000 door, but the panel is made out of 98% post-consumer recycled content. The window is approximately 80% pre-consumer recycled content and the spine is recycled anodized aluminum with 81% recycled content, 57% pre-consumer, and 24% post-consumer.

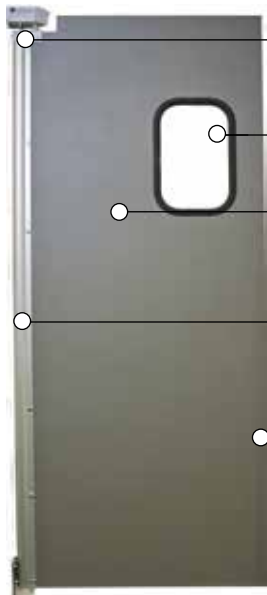

Hinge – Proven hinge system mounts to the jamb with offset cam system and hardened rollers, for years of service with minimal maintenance.

Window & Frames – 9” x 14” windows are made with approximately 80% pre-consumer recycled content.

Door Panel – Lightweight, durable doors are constructed with 1/2” thick recycled material and are currently available in gray. The color is throughout the door panel and textured to hide normal dents and scratches. Complies with FDA Food Code 2009: 4-101.19 Nonfood Contact Surface.

Back Edge Spine – Back edge spine is a one-piece, continuous extruded 1/4” x 2” diameter anodized aluminum tube with flanges that radius the door panel for added strength and durability. The recycled content is 81% with 57% pre-consumer, and 24% post-consumer.

Leading Edge – Leading panel edge is beveled for safety.

From www.usgbc.org

Table MRc4-1. Summary for Recycled Content

- Sustainable criteria value of post-consumer + 1/2 pre-consumer recycled content.
- Recycled content value as a percentage of total materials cost - Must be at least 10% for 1 point, 20% for 2 points, 30% for exemplary performance.
- Percentage of MRc4 materials with cutsheets provided (by cost) - Must be at least 20% to document credit compliance.

Here is an Example:

- If you have an 84” x 84” EcoSwing Door
- The standard 9” x 14” recycled window
- Total recycled content is 78% (74% post -consumer, 4% pre -consumer)

Based on product cost, approximately \$75 out of every \$100 of the purchase price would contribute to LEED credits!

Table MRc5-1. Summary for Regional Materials

- Sustainable criteria value of materials manufactured and extracted/harvested/recovered within 500 miles.
- Regional materials value as a percentage of total materials cost - Must be at least 10% for 1 point, 20% for 2 points, 30% for exemplary performance.
- Percentage of MRc5 materials with cutsheets provided (by cost) - Must be at least 20% to document credit compliance.



The Chase EcoSwing will help Contribute to your LEED Credits in the Following Ways:

LEED MR Credit 4 - Recycled Content

Materials that contain both pre-consumer and/or post-consumer recycled content will help contribute towards LEED credits. Recycled content is calculated based on the amount of recycled material in the product, either from a product weight or product cost standpoint (varies by project). For any pre-consumer recycled material content, you will receive 50% of recycled dollar value, but for post-consumer recycled material content, you will receive the full 100% of the recycled value.

LEED MR Credit 5 - Regional Materials: Extracted, Processed and Manufactured

Plus if your project is within 500 miles of the Chase Doors factory in Cincinnati, Ohio the EcoSwing would contribute towards this credit.

LEED is a trademark owned by the U.S. Green Building Council[®] and is used with permission.



Chase SD 2000 Series

Chase SD 2000 Series Service Doors weigh significantly less than impact doors, making them easier to open and more popular in light duty applications where low costs and aesthetic appeal are considerations. Café style door with gate hinge also available.



Hinge – Proven hinge system mounts to the jamb with hardened steel cam and roller, for years of service with minimal maintenance.

Window & Frames – Windows are 9” x 14” acrylic set in black rubber molding.

Door Panel – The doors are constructed with .063” anodized aluminum. A decorative, high-pressure laminate finish is available on one or both sides. Approximate weight for each panel is 1-3/4 PSF.

Back Edge Spine – Back edge spine is triangular formed for vertical panel stiffness and added durability.

See page 11 for standard laminate colors

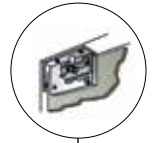

E Hinge
Classic “E” hinge has a removable aluminum cover for easy maintenance.



Leading Edge
Leading edge is triangular formed for vertical panel stiffness and edge protection, reducing potential damage.

Applications	Environment	Options
<ul style="list-style-type: none"> • Institutional • Restaurant • Retail • Supermarket • Food Service 	<ul style="list-style-type: none"> • USDA Accepted • Personnel • Interior 	<ul style="list-style-type: none"> • Lower Hinge Guards • Window Options • Impact/Kick Plates • Cart Guards • High Pressure Laminate

Light to Medium Duty Service Door

Chase SST 2000 Series

Whether you are looking for a high-tech, retro or simply a classic look, the Chase SST 2000 stainless steel doors add an upscale touch of class to any decor. The SST 2000 light duty service door is the perfect choice for applications that require aesthetics, affordability, cleanability, low maintenance, easy installation, dependability and durability.

Applications	Environment	Options
<ul style="list-style-type: none"> • Restaurants • Retail Stores • Supermarkets • Convenience Stores • Pharmacies 	<ul style="list-style-type: none"> • USDA Accepted • Personnel • Interior 	<ul style="list-style-type: none"> • 9” Lower Hinge Guards • Window Options • Impact Plates • Cart Guards

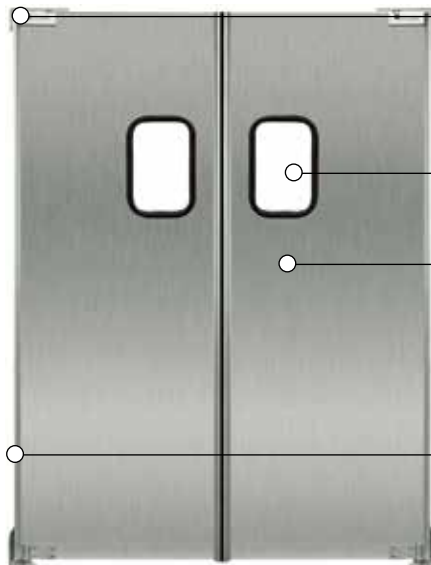

Hinge - Proven hinge system mounts to the jamb with hardened steel cam and roller, for years of service with minimal maintenance.

Window & Frame - Windows are 9” x 14” acrylic set in black rubber molding.

Door Panel - Constructed with 16 gauge stainless steel with #4 brush finished. It will not warp or crack and can outlast aluminum. It’s extremely durable and offers a beautiful aesthetic appeal. Requires low maintenance with no special treatment or painting, only occasional polishing to keep its shine.

Back Edge Spine - Back edge spine is triangular formed for vertical panel stiffness and added durability.

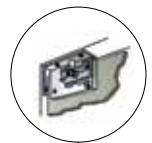

E Hinge
Classic “E” hinge has a removable stainless steel cover for easy maintenance.



Leading Edge
Leading edge is triangular formed for vertical panel stiffness and edge protection, reducing potential damage.



Chase SRP Self-Standing Gate Door

The Chase SRP Self-Standing Gate Door is ideal for use in retail areas where small children might wander in and potentially get hurt and any other areas where some sort of wall structure does not exist to hang a double acting door. This free standing door is an excellent option for safeguarding customers from potentially dangerous areas.



Visibility - For additional visibility, the panel is raised 10" from the floor and is 38" in height. The complete door system stands 48" high.

Hinge - The Ultra-Soft Touch™ assisted gravity hinge system is "hidden" in the back spine.

Panel Construction - Lightweight durable doors are constructed of 1/2" thick USDA accepted stress relieved high-density polyethylene. The door panels are textured and have the color throughout, hiding normal dents and scratches. HDPE material meets industry standards maximum allowable panel deflection of a 1/4" per 36".

Steel Posts - 3-1/2" diameter sturdy steel posts are standard powder coated gray, but optional black and white are available as an option. This door comes completely assembled, no frame or jambs needed, just anchor to the floor. Available with either core drill installation for a permanent barrier or a foot plate for a temporary barrier.

Standard Hidden Hinge System – The full length back spine contains the in-line cam, coil spring gravity assist hinge system that helps the door close fast. The hinge allows for an extra wide swing, reducing damage from "wrapping" the jamb. Panel centering adjustment is located at the bottom of the door.

Colors Available for SRP Self-Standing Gate Door

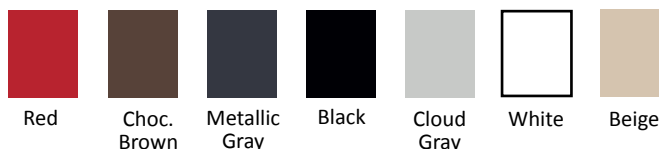

Color shown may differ from actual color. Consult factory for exact color match.

In-Jamb Gate, Café and Saloon Doors

In-Jamb Gate, Café, and Saloon style doors provide visual separation and aesthetic appeal. Available in a variety of finishes including: high pressure laminates, ABS plastic, SRP stress relieved high-density polyethylene, stainless steel, aluminum or galvanized steel. Gasketing and windows are available as options. Several different styles and models are available:

- Model 2000 Gate/Café door is constructed with .063 thick aluminum. Model 2002 Gate/Café door is constructed with .063 thick aluminum with high pressure laminate on one or both sides. Standard hinge is Chase gravity hinge with aluminum hinge cover.
- Model ABS 5000 Gate/Café door is constructed with 1/4" thick ABS plastic, textured on front side, smooth on the back side. The back edge spine is 3/4" thick ABS with a stainless steel channel. Hinge system is hidden hinge as shown above.
- Model 3000 Gate/Café door is constructed with a 3/4" solid wood core with .032" thick anodized aluminum cladding. Standard hinge is Chase gravity hinge with a black hinge cover.
- Model 3002 Gate/Café door is constructed with a 3/4" solid wood core and high pressure laminates on both sides. Standard hinge is Chase gravity hinge with a black hinge cover.
- Model 3002SS Gate/Café door is constructed with a 3/4" solid wood core and stainless steel. Top, bottom and back spine are covered with stainless steel edge trim. Standard hinge is Chase gravity hinge with a stainless steel hinge cover.





AirGard® Flexible Doors

Flexible Doors are a cost-effective way to provide a swing door on openings for heavy traffic applications. Top Mounted Gravity-Operated Hinge System allows the door to open fully and close automatically, allowing easy access and conserving energy. These doors are easy to install and virtually maintenance free.



Wipers – For a positive seal, balloon jamb edge seals and top and bottom wipers are provided. The top and bottom wipers consist of two-ply vinyl coated nylon for a positive seal.

Top Mounted Gravity Hinge – Standard with the Chase top-mounted gravity hinging system that opens instantly upon contact, then closes automatically by gravity.

Windows – Various window configurations are available, type 50 (centered in each panel) is standard.

Door Panel – Inherently strong and abrasion-resistant, these doors are constructed of two-ply “belting” material. Layers are bonded together without the use of rivets or stitching eliminating the possibility of contamination. Each door panel includes two rows of flexible horizontal stays. Suitable for low temperature applications to –30°F. Available in forest green only.

Leading Edge – 3” overlap at the center provides a noise and temperature barrier.

Jamb Edge – 2” balloons are provided on the jamb edge for a superior seal that saves energy.

AirGard Model 300



AirGard Model 973

- Built for the toughest applications these doors are constructed with a .160” thick PVC door body, and a two-ply vinyl coated nylon bracket pocket. Embossed finish resists scratches, scuffs and abrasions. Pocket colors available in black and forest green. **Not suitable for freezer applications.**
- For a positive seal, balloon jamb edge seals and top and bottom wipers are provided.
- 3” overlap at the center on bi-parting doors provides a noise and temperature barrier.
- 48” high USDA accepted textured vinyl impact plates on both sides of the door panel are used to increase the strength and durability of the door panel. See page 20 for impact plate color options.
- The viewing area is extra large to allow clear visibility and maximum safety.
- Standard with the Chase top-mounted gravity hinging system that opens instantly upon contact, then closes automatically by gravity.



AirGard Model 100

- Constructed of 45 oz. USDA accepted, abrasion-resistant, vinyl coated nylon material. Each door panel includes one row of flexible stays.
- Wipers are provided at the top, bottom and on the jamb sides.
- Various window configurations are available, 30” x 14” is standard.
- 3” overlap at the center provides a noise and temperature barrier.
- Complete with the Chase top-mounted gravity hinging system.
- Optional impact plates are available for abusive applications. Pocket weights are provided at the bottom of each panel when impact plates are not used.
- **Model 100E** – The same construction as the Model 100 but includes 48” high impact plates on both sides of the panel.
- **Model 100CSE** – The same construction as the Model 100 but includes full height impact plates on both sides of the panel.



Top Mounted Gravity Hinge

The “original” top mounted gravity-operated hinge system allows the door to open fully and close automatically. Optional bracket arm adjustment feature compensates for jambs that are not plumb.

Applications	Environment	Options
<ul style="list-style-type: none"> • Food Processing • Industrial • Institutional • Warehouse 	<ul style="list-style-type: none"> • Freezer • Cooler • USDA Accepted • Personnel • Interior 	<ul style="list-style-type: none"> • Window Options • Impact/Kick Plates • Hinge Options • Color Options (page 20)



Chase Flexible Doors

Over 70 years ago, Chase Doors pioneered the original flexible AirGard® door with its unique Top Mounted Gravity Hinging System and it is still on the job today. Flexible doors are a cost-effective way to provide a swing door on openings for heavy traffic applications. These traditional doors provide a maximum opening clearance for wide loads. Replacement for existing doors is fast and easy due to simple construction of a top-mounted gravity hinging system.



Wipers – For a positive seal, balloon jamb edge seals and top and bottom wipers are provided.

Window – Various window configurations are available, shown is 30" x 14". Standard configuration is type 50 centered in each panel.

Door Panel - Constructed of two layers of USDA approved heavy-duty, abrasion-resistant, textured PVC laminated back to back. Each door panel includes two rows of flexible horizontal stays to add vertical stability.

Leading Edge – 3" overlap at the center provides a noise and temperature barrier.

AirGard Model 200 shown with optional 30" x 14" window configuration.



Uni-Flex 240

- Constructed of two layers of .120" PVC, laminated together to a thickness of .240".
- Embossed finish resists scratches, scuffs and abrasions.
- Various window configurations are available, type 50 (centered in each panel) is standard.
- 3" overlap at the center provides a noise and temperature barrier.
- Complete with the Chase top-mounted gravity hinging system.



Top Mounted Gravity Hinge

The "original" top mounted gravity-operated hinge system allows the door to open fully and close automatically. Optional bracket arm adjustment feature compensates for jambs that are not plumb.

Colors Available for AirGard 973



Forest Green Black

Colors Available for AirGard 200 and Uni-Flex 240 Doors, & AirGard 973 Impact Plate Colors



Forest Green Navy Red Black Med. Brown Chocolate Brown Metallic Gray Royal Blue Beige Dolphin Gray

Color shown may differ from actual color. Consult factory for exact color match.

Structural Tube Frames, C Channel Frames, and Flush Hollow Metal Frames



Structural Tube Frames

Structural tube frames are custom manufactured of tubular steel to fit your particular door opening. Designed for heavy doors in industrial type of applications or applications where the wall can not support the door. They are shipped knocked-down in three easy to assemble pieces. The vertical members are placed on the floor, the header section slides into the position, and mechanically fastens to the vertical sections with four bolts. The frame is raised into the rough opening and simply anchored to the floor (two anchors per side) and the jamb. Chase structural tube frames are available for standard and industrial applications and are pre-drilled for any of our hardware configurations so installation is quick and easy. Just supply us with your finished opening height and width. Standard color is powder coated gray, optional powder coated black, beige or white. Stainless steel and galvanized wraps are also available.



C-Channel Frames

C-Channel frames are custom manufactured for each opening in opening size, as well as wall thickness. C-Channel frames are manufactured of carbon steel, and are powder coated for corrosion resistance. When structural reinforcement is not required, C-Channel frames are cost effective option for traffic doors. C-Channel frames ship in three pieces, and are mechanically fastened to the wall on all sides. The header assembly includes internal reinforcement plates that fasten to the side members when the door is installed. As with our Structural Tube Frames, C-Channel frames are pre-drilled for installation of any Chase traffic door. This insures that the door is properly mounted, and reduces the labor to complete the door and frame installation. Standard finish on C-Channel Frames is powder coated gray. Optional black, beige and white finishes are available, as well as galvanized and stainless steel finishes.



Flush Hollow Metal Frames

Chase Flush Hollow Metal Frames are an excellent choice for traffic door installations with light to medium traffic. Flush hollow metal frames are best suited for drywall constructed walls, but can also be used in block walls. All Chase flush hollow metal frames have internal steel reinforcement for installation of traffic door hardware. Chase flush hollow metal frames ship knock-down, and are easily assembled on site for quick installation. Frames can be butt mounted on block, or wrapped onto drywall constructed walls. Chase flush hollow metal frames ship prime painted or factory galvanized, and are finish painted after installation. Flush hollow frames are a cost effective option for light to medium abuse applications.



Econo Max[®] Strip Doors



Econo Max Strip Doors offer an economic alternative for applications where environmental control is required. Strip Doors act as an effective barrier, while allowing unimpeded traffic flow for personnel, materials or equipment. With a variety of materials and mounting options, Econo Max Strip Doors can be fitted to virtually any opening size. Strip doors offer added temperature control when used in conjunction with cooler and freezer doors, saving energy and reducing moisture buildup. Strip Doors can be used to provide barriers around equipment, or to partition large warehouse areas into different areas. With a wide variety of mounting options and different materials to choose from, we'll design a system for you.

Largest Selection of Strip Material

Chase has a state of the art extrusion line capable of offering a wide variety of PVC materials and sizes. Choose from 7 different vinyl strip formulations in 6 different widths and 4 different thicknesses with over 36 different combinations of characteristics.



- **Standard Clear PVC** – Our clear PVC strips are designed for use in warehouses, dock and walk in coolers with temperatures above 32 degrees.
- **Loc-Rib** – Our standard and low temp PVC strips can be fabricated with "locking" ribs that reduce drag on products passing through the opening. Loc-Rib material also offers better resistance to air flow, and is more durable than standard material extending the life of the strip door.
- **Anti-Static** – Clear strip formulation to dissipate static electricity harmlessly away from personnel or sensitive equipment.
- **Safety Orange** – Used to identify the edges of an opening for traffic passing through an opening, and to reduce potential damage to walls and jambs.
- **Low Temp Material** – For use in coolers and freezers, Low Temp PVC is designed to remain pliable to temperatures as low as -20 degrees.
- **Amberweld** – Specially formulated to screen out UV and near UV rays from welding and brazing flash. Pliant at temperatures down to -20°F.
- **Colorview** – We add windows to attractive opaque colored strip doors by RF welding clear sections into the center of the strips. Available in black and blue.

Chase Doors Econo Max strip material (except low temp) is registered with the California Department of Forestry and Fire Protection as a flame resistant product.

Bracket Options with Proven Performance

Our in-house engineering department has developed unique hardware systems that provide solutions to hundreds of simple or challenging strip door mounting problems.

- **EconoTrack Mounting Bracket** – The most popular design in the industry, its simple replacement features allows the customer to replace individual strips cut-to-size from the factory, or cut and punch in the field. The durable, versatile EconoTrack Bracket can be used for both surface and in-jamb mounting on small or very large openings. EconoTrack's formed steel face plate holds strips firmly while allowing flex without breaking. These rugged brackets are constructed of 14 gauge galvanized steel with ¼" face plates are formed in 12" sections for easy strip replacement.
- **Bi-Mount Mounting Bracket** – In the unique J-Hook system, J-Hook hangers—each with a strip attached – are hung from a 2-part extruded aluminum bracket. Hangers are easily lifted out to replace strips. A continuous welded bond between each strip and its J-Hook insures long life. Installation is simple, just screw the aluminum mounting hardware flush to the wall, or to brackets in the door jamb, or any other special mounting hardware. Then hang the J-Hook mounted strips into place and tighten the clamping bolts. Strips will hang straight and level with the correct overlap. Lifetime warranty on strip heat seal – if strips ever come unsealed from the J-Hook we guarantee free replacement including freight.
- **Overhead/Roll-Up Door Bracket** – Extends out and around the door assembly so strips can be mounted inside the building for protection from weather and vandalism when the exterior door is closed.
- **Gate Hinge** – Allows the strip door to be swung out of the opening when not required. A retractable bolt locks the hinge in place.
- **Trolley Mount** – The strip door can be parted in the center or rolled to one side using this heavy duty roller/track assembly.





Fast-Mount Strip Door

Chase Doors makes the job of hanging strip doors even easier with our new Fast-Mount strip door system. The Fast-Mount design eliminates multiple studs and fasteners, and ensures a simple, fast installation. A 3' x 7' strip door can be installed in a matter of minutes. Simply attach the mounting bracket to the wall, slide the J-Hook Strips into the bracket and install the locking screws at each end to hold the strips in place. No more time consuming layout, measuring or calculating overlap of strips. Fast-Mount strips are designed so that they install and establish a preset overlap when you slide them into the bracket.



Fast-Mount Advantages

- J-Hook strips slide easily into low profile bracket & can be replaced in little or no time.
- J-Hook strips are tapered, making installation fast and easy.
- When you are ready to install, just open, hang and you're done!

Installation is Easy as 1, 2, 3!

- Attach the mounting bracket to a flat surface above opening.
- Start at either end and slide the J-Hook Hanger/Strips along the center track in the Fast-Mount bracket until all strips are installed.
- Install locking screws in each end of bracket to hold the strips in place and you done - fast and easy!



EconoClear® Flexible Door

EconoClear Flexible Doors are a cost-effective way to provide a swing door on openings for heavy traffic applications where complete visibility is required. The top mounted gravity operated hinge system allows the door to open fully and close automatically, allowing easy access and conserving energy. All EconoClear doors are custom manufactured to your specific opening size requirements. They are easy to install and virtually maintenance free.



Self-closing gravity hinge has zinc base and stainless steel arm for strength and corrosion resistance.

- Designed for use in walk-in coolers, food preparation areas and any other application where conserving energy and complete visibility is essential.
- The door panel is constructed with clear .120" PVC vinyl for complete visibility and maximum safety. Optional low temperature or anti-static material is available.
- Optional impact plates are available for abusive applications.
- Not recommended for motorized traffic.

Applications	Environment	Options
<ul style="list-style-type: none"> • Food Service • Retail • Institutional • Warehouse • Cold Storage 	<ul style="list-style-type: none"> • Cooler • Freezer • USDA Accepted • Personnel • Interior & Exterior 	<ul style="list-style-type: none"> • Impact/Kick Plates • Material Options

Econo Max® PerfaStrip®



Chase Doors makes the job of replacing vinyl strip door strips easier by offering pre-punched and perforated rolls of Econo Max PVC Strip material. PerfaStrip, the latest addition to the Chase product line, is a continuous roll of PVC strip material that is pre-punched and perforated to your specified length. Installation is as easy as 1, 2, 3! Simply pull out one strip, tear off of the roll at the perforation and hang.



Fits Most Hardware

The PerfaStrip pre-punched replacement strip material is designed to fit Chase Doors' EconoTrack bracket, but will fit most competitors bracket styles.

PerfaStrip Advantages

- Pre-cut and pre-punched to your exact length
- Installation is fast and easy - no drilling or cutting
- Fits most existing hardware
- Easy to store
- Hangs flat right off the roll
- Available in all Econo Max strip material & sizes up to 16" wide

Hangs Flat Right off the Roll!

Most replacement strips are shipped either folded or on small rolls, causing the strip to deofrm or remain curled after hanging. With PerfaStrip, you simply roll the strip out, tear and hang the strip on the bracket. PerfaStrip replacements strips hang "right off the roll!"

Vinyl Roll Goods

Chase Doors is one of only four companies in the U.S. to extrude clear vinyl strip material used in the fabrication of strip doors. Plus Chase has two full service strip door production facilities, which means quick lead times to the West from its Oregon Facility and to the East from its Ohio facility, so you get the best quality material and at the best price.

Largest Selection of Strip Material in the Industry. Plus we maintain a large stock PVC strip rolls in a variety of formulations in order to meet short lead times. All Econo Max vinyl roll goods are extruded from self-extinguishing PVC with rounded edges to protect personnel and products.

Materials include:

- Standard Clear
- Loc-Rib
- Colorview
- Safety
- Anti-Static
- Amberweld
- Low Temp





DuraShield®

DuraShield Bug, Bird and Wire Mesh Door Systems are a cost effective way to provide ventilation and natural sunlight to buildings while maintaining a bird and insect free environment. With a variety of options and panel types, DuraShield Door Systems offer protection from unwanted pests, and limit access into buildings or specific areas inside a facility. DuraShield doors are designed for easy installation, and can be set up to work in conjunction with existing door systems. The doors can be placed on the inside or outside of a building, and can be mounted either in jamb, on the face of the wall or with standoff brackets. All systems are available manual or motor operated. Sliding doors are also available.



Bug and Bird Screen Doors

- Doors are constructed with a durable vinyl encapsulated woven polyester mesh that is resistant to mildew and color fading.
- The Bug Screen Door material utilizes 17 x 11 scrim count plain weave and 11.7 oz. per square yard of material in your choice of standard colors.
- The Bird mesh standard material utilizes netting, a special oval shape weave with 9 holes per square inch and 15 oz. per square yard of material. Standard panel color is blue.
- Durable, yet lightweight, the deep channel aluminum track system tightly secures the panel in the opening. The aluminum track flairs out at the top of the guide curtain material for easy, smooth and reliable operation.
- Each door includes round 3/4" diameter horizontal fiberglass stiffeners for draft resistance and horizontal stability. An optional 1" diameter metal tube is available for wider openings or high wind load applications.
- The bottom pocket uses a bright yellow, vinyl coated nylon and a hem chain for added weight preventing crawling critters from getting free passage at the floor contact point. Uneven or slanting floors are not a problem, additional weight along with a lockable bottom bar is available.
- Safety yellow and black strips are standard on the vertical upright side members.

Wire Mesh Doors

- Doors are constructed with 15 gauge aluminum with 1/2" coil wire mesh. Other panel options include 18 gauge aluminum with 1/4" coil, 16 gauge stainless steel with 1/2" coil, and 19 gauge stainless steel with 1/4" coil.
- Heavy duty extruded aluminum "C" channel guide tracks are 1.25" wide x 4" deep.
- Horizontal stiffeners are constructed with 3/4" fiberglass wind load rods and are inserted into specially constructed coils for horizontal stability, visibility and increased safety.
- A solid bottom bar with a lock down system is standard.
- Safety yellow and black strips are standard on the vertical upright members.
- Heavy Duty roller tube assembly is 3" - 6" in diameter and is dependent upon the size of the door.
- All wire mesh doors come standard with in-tube motor for small doors or external motor for larger doors.



Solid Vinyl Roll-Up Door

- Doors are constructed with a 22 oz. durable vinyl coated nylon material that is resistant to color fading and can be washed down. An optional, heavy duty panel constructed of 40 oz. material is available. Contact factory for choice of colors.
- Durable, yet lightweight, the deep channel aluminum track system tightly secures the panel in the opening. The aluminum track flairs out at the top of the guide curtain material for easy, smooth and reliable operation.
- Each door includes round 3/4" diameter horizontal fiberglass stiffeners for draft resistance and horizontal stability. An optional 1" diameter metal tube is available for wider openings or high wind load applications.
- The bottom pocket uses a bright yellow, vinyl coated nylon and a hem chain for added weight preventing crawling critters from getting free passage at the floor contact point. Uneven or slanting floors are not a problem, additional weight along with a lockable bottom bar is available.
- Safety yellow and black strips are standard on the interior edge of the panel.
- When panel opening speed is not critical, it is an excellent low cost alternative to a high speed door.





DuraSpan Industrial Curtain Wall

Founded in 1932, Chase Doors has become the global leader and most recognized manufacturer of high-quality, made-to-order specialty door systems and flexible wall partitions. Chase Doors offers both an industrial and insulated curtains designed to economically divide space without building a permanent wall. No matter what model you choose, Chase Doors' manufacturing capabilities and exceptional customer service has empowered Chase Doors to earn a reputation for high quality products that are reliable, durable and competitively priced.

The DuraSpan Industrial Curtains are an economical solution to dividing work space and are more versatile than building permanent walls. Whether you want to separate production areas, create smaller work areas, contain dust and contaminants or simply create a barrier for your employees' comfort and productivity, an industrial curtain is an excellent solution. DuraSpan Industrial Curtains allow you to maximize your available space and provide easy installation, retractability and mobility not available in permanent wall fixtures.

DuraSpan Industrial Curtains are made with durability in mind, constructed of reinforced flame retardant vinyl and mildew resistant thread. The flame retardant vinyl meets NFPA 701 requirements and the California Fire Marshal Standard*. Industrial curtains are available in 18 oz. material in an array of colors. The top of the curtain has a reinforced sewn hem with stainless steel grommets available in 12", 18" or 24" increments. Every industrial curtain can be customized to suit your specific need.



- **Temporary or permanent walls** - the no-fuss industrial curtain stays up as long as you like, but can easily be moved to different areas, giving you the versatility needed to get the job done.
- **Prohibits abrasive material** – whether you are grinding metal or working with fiberglass, the DuraSpan Industrial Curtain will safely protect your employees.
- **Fire resistant solution** – DuraSpan Industrial Curtain material meets flame retardant code NFPA701 and California Fire Marshal Standard*.
- **Sound abatement** – the curtains create a more comfortable, productive work environment by reducing noise.
- **Thermal temperature difference** – help control the temperature in certain areas of a facility, reducing energy and saving money.
- **Space savings** – with optional track system, the industrial curtain can retract or expand within seconds, either dividing space or keeping it open.
- **Control dust and airborne particulates** – create privacy for your employees or keep unsightly areas screened from view.
- **The choice for fast and easy installation** – simply hang the curtain on an existing mounting structure or on our track system. To install on our track system, just fasten the track to the ceiling, slide in the trolley wheel and hang the curtain— as easy as 1,2,3!

The DuraSpan industrial curtain is your solution for manufacturing, warehousing, food processing, distribution centers, data centers, automotive or airport bays, gymnasiums, demolition, remodeling and other applications that require an economical, durable barrier. The no-fuss DuraSpan industrial curtain with optional track system can retract or expand within seconds, giving you the versatility needed to get the job done.





DuraSpan Insulated Curtain Wall

The DuraSpan Insulated Curatin Wall is the perfect solution for refrigerated areas, food processing facilities, production facilities, distribution centers or any other area that requires temperature separation. DuraSpan Insulated Curtain Walls offer all of the same great features as the DuraSpan Industrial Curtain, plus it offers a barrier for temperature control. With several different R-values available, DuraSpan can meet most thermal specifications with ease. Contact the factory for more information.

- No-fuss insulated curtain stays up for any desired amount of time but has the versatility to be moved wherever needed to meet your facility’s needs.
- The DuraSpan Insulated Curtain material meets flame retardant code NFPA701 and California Fire Marshal Standard*.
- The curtain can retract or expand within seconds with our optional track system, giving you the flexibility to open and close quickly in the area as need.

Additional Options Include:

- Bottom hem for pipe or chain
- Glued adhesive option
- Track & trolley hardware (a few options are shown to the left)
- Vertical stiffener pockets
- Cut out reinforced hand pulls
- Panel connections with pressure sensitive hook & loop (standard on insulated curtain)
- 6” floor sweep
- Windows



DuraSpan™ Options



Standard Track



Ceiling Support Mount



Curved Track



End Stop



Track Splice Wall Mount Down



Standard Roller

Colors Available in 18 oz.

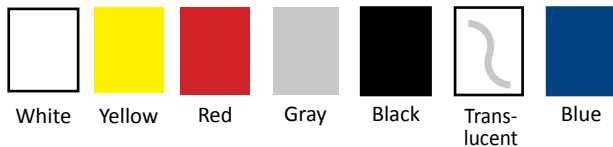

Color shown may differ from actual color. Consult factory for exact color match. Additional colors available from factory.

*Consult factory for fire certifications, which may vary by material type!



Durulite® CR 1400

In high abuse interior applications, consider the Durulite CR1400 corrosion resistant door system. The Durulite CR1400 is impervious to acids, petroleum products, animal fats and cleaning solvents, and will take a punch like no other door system. The door panel is constructed using rotational molding technology, creating a one-piece outer skin of high density polyethylene. The interior core is ultra-high density urethane foam. This combination results in a panel that will absorb impact and perform well in the most difficult conditions. Durulite CR1400 door panels are not designed for exterior applications.



- **Door Surface** – Seamless panel construction makes this door ideal for abusive, washdown applications. The sanitary surface never needs painting and cleans easily with soap and water.
- **Door Panel** – Constructed with a 1/8" thick outer skin of rotationally molded polyethylene with an ultra-high density, NON-CFC urethane foamed-in-place core. The panel can retain its properties from 30°F to 100°F continuous service, and 140°F intermittent service with temperature differences of up to 40°F. The overall thickness of the panel is 1-3/4", yet weighs only 3.66 pounds per square foot, making it lightweight and easy to open.
- **Insulation** – The Durulite CR1400 has excellent insulation qualities with an EcoMate foamed-in-place NON-CFC urethane core. EcoMate insulation is designed to be environmentally friendly; it was awarded VOC (Volatile Organic Compound or SMOG) Exempt Status by the EPA.
- **Gasketing** – All doors come standard with a replaceable bottom sweep, and are available with a drop down seal.
- **Hinges** – Optional high quality stainless steel hinges mount the Durulite CR1400 securely to the frame and provides years of service.
- **Lite Kit Options** – Durulite CR1400 door systems can be equipped with a variety of lite configurations. Optional glazing includes clear polycarbonate in single or double pane units and can be set in your choice of stainless steel or two-piece injection molded, low profile PVC lite kits. The stainless steel lite kits can either be surface mounted or flush mounted for pharmaceutical applications.
- **Additional Options** – Every Durulite CR1400 is custom manufactured to the exact specifications of each opening. Durulite CR1400 doors can be ordered with passage/locksets, door closers, panic devices, push/pull handles, kick plates, louvers, astragals, flush bolts, bottom sweeps and weather-stripping.

Durulite CR1400 Frames

Chase offers both pultruded fiberglass frames and stainless steel frames for the Durulite CR1400 door system. Either frame can be butt mounted or wrapped for most wall conditions, including insulated panel walls. The frames are available with a variety of mounting systems.

Fiberglass frames are constructed of 1/4" thick, pultruded fiberglass. The corners are mitered with no exposed fasteners for a clean finish. Fiberglass frames are available in 4" wide (single rabbet) or 5-3/4" wide (double rabbet) profiles. Reinforcements are placed inside the frame for additional strength.

The stainless steel frames come standard with type 304 material, and are available in 316 Stainless if required. Stainless steel frames are available for virtually any wall thickness and can ship knock down, face welded or fully welded. Single or double rabbet frames can be manufactured for walls as narrow as 3" or as wide as 12".

Durulite CR 1400 Standard Colors



Color shown may differ from actual color. Consult factory for exact color match. Additional colors available from factory.



Fib-R-Max[®], Fib-R-Dor[®] & Fib-R-Lite[®]

Fib-R-Max[™], Fib-R-Dor[®] and Fib-R-Lite[™] fiberglass doors are designed for interior and exterior applications and when required can be equipped with labels to meet fire and storm rating requirements. All three door systems have been tested and approved for both neutral and positive pressure by Intertek Testing Services. The doors systems are available with 20/ 45/ 60 and 90 minute labels by Warnock-Hersey with UBC 7-2-1997 and UL 10c NFPA 252 for positive pressure fire rated doors. The doors have received the Florida Building Code (FBC) approval for installation in high velocity wind zones. Plus they exceed the standards set forth for large missile impact (ASTM-E1886/1996 missile level D), both positive and negative cycle pressure and wind load. In addition, Fib-R-Max has received the Texas Department of Insurance (TDI) approval for installation in high wind coastal areas.



Fib-R-Max Fiberglass Doors

Designed for pharmaceutical manufacturing, chemical manufacturing and cleanroom applications, Fib-R-Max is the strongest, most durable and dependable fiberglass door on the market meeting USDA, FDA and cGMP compliance. Fib-R-Max door systems are engineered to withstand repeated washdowns and rigorous cleanings with corrosive agents such as acids, disinfectants and cleaning solutions while remaining beautiful year after year.

- Industry leading, 25 mils of integrally molded gel coat finish provides a beautiful aesthetic appeal with a high gloss and an impenetrable barrier against corrosive chemicals and environmental attack. When requested, Fib-R-Max is available with specifically formulated gel coat for FDA/USDA applications, or high UV resistance. Standard high gloss colors for Fib-R-Max include white, tan, brown and gray, but additional pre-matched colors and custom color options are available.
- The interior cavity of the fiberglass door is completely filled with a corrosion-resistant material. The standard core material is polypropylene honeycomb. Optional cores include polyisocyanurate foam, end grain balsa, and gypsum materials. Gypsum core material is used on fire rated doors and frames. Fib-R-Max doors can be engineered for excellent sound attenuation, high R Values and durability.

Fib-R-Dor Fiberglass Doors

Fib-R-Dor fiberglass door system is a beautiful, durable door designed for use in pharmaceutical manufacturing, food processing, water and wastewater treatment, chemical manufacturing, oil refineries, pulp and paper mills and any other application where doors are subject to severe corrosive conditions. Fib-R-Dor door systems are for use in exterior and interior applications and are USDA, FDA and cGMP compliant.

- Fib-R-Dor utilizes a unique “outside-in” manufacturing process, creating a highly durable panel with no seams, gaps or potential failure points. Designed for use in facilities that require regular cleaning with harsh chemicals, the seamless construction eliminates particulate “catch” points that make traditional doors difficult to sanitize. The entire exterior of the door panel is molded fiberglass with a permanent bond to the core material, ensuring a beautiful, durable, low maintenance door that will last an extremely long time. Fib-R-Dor fiberglass door color is a molded gel coat finish, so it will never corrode, need to be painted or discolor like steel and aluminum doors.



Fib-R-Lite Fiberglass Doors

Fib-R-Lite fiberglass door systems are the only choice when your application demands durability, quality, performance and value in a corrosion resistant door. Fib-R-Lite fiberglass doors are designed to stand the test of time in challenging conditions including food processing, food service, institutions, and car washes. Fib-R-Lite doors are also an excellent choice for coastal applications including exterior openings with high humidity and severe wind conditions.

- Fib-R-Lite’s door surface comes standard with a fine pebble textured finish and is available with a post-applied 15 mil gel coat matte finish. Both finishes are resistant to harsh chemicals, cleaning agents and saltwater. The standard gel-coat finish eliminates the need for field finishing, and is comparable to the strength and durability of 20 coats of paint.
- Fib-R-Lite doors are custom manufactured to your exact specifications and can be ordered with a variety of louvers, transoms, astragals, bottom sweeps and weather-stripping.

Saino® & DuruSlide®



Chase offers the most comprehensive line of specialty door systems from modular construction manual sliding door systems to microprocessor controlled automated barrier systems to UL & FM labeled fire doors that can be in washdown applications. Every system is designed and manufactured with the latest technology, insuring all door systems are reliable, durable and competitively priced. In fact, the Saino brand has been a recognized leader in the industrial door market since 1899.

All Chase single slide and center parting doors can be operated manually or be equipped with a variety of drive systems including microprocessor controlled operators that can be connected to process control or monitoring equipment. Manual door systems can be equipped with an automatic closing system that provides a positive closure at controlled speeds, insuring effective environmental control and personal safety.



Saino Sliding Fire Doors

Saino UL approved fire doors can be used in both single slide and center parting applications with up to 4 hour UL labels making them acceptable for most applications requiring fire barriers. FM labels and temperature rise labels are also available, providing an added level of safety in areas where personnel are present. All Saino Door Systems can be automated, allowing the door to be used as a functional door system as well as a fire door. This two-in-one feature reduces the cost of providing multiple door systems in a single opening and insures that the door will be operational in the unlikely event of a fire. Additional benefits include:

- All Saino listed and labeled operators comply with ANSI standards and are listed and labeled for use as an automatic closure device. Automated fire doors can be connected to a central fire system, increasing personnel safety and minimizing potential damage caused from fires.
- Automated fire door systems come complete with a self-contained, standby power supply that is approved under UL 228 and UL 924 as tested for critical components.
- Saino sliding fire doors can also be equipped with pass doors including multiple doors for double egress.
- Chase is the only manufacturer that has the ability to provide a fire door with a 12" headroom clearance.

Saino Sliding Industrial Doors

Chase manufactures non-labeled Saino sliding door systems to the same high standards that are maintained for fire door systems. Saino sliding doors offer options that will satisfy almost any non-labeled sliding door application, including warehouse doors, doors with high wind load, or wall openings that provide access to oversized manufacturing equipment.

- Modular panel construction with 18 gauge face sheets and internal steel reinforcement channels insure panel rigidity in a lightweight design.
- Finishes include prime painted steel, stainless steel, Kydex, or fiberglass.
- A variety of options including vision panels, track hoods, pass doors and perimeter gasketing allow the door to be customized to meet the needs of each application.
- Available manual or motor operated.



Sliding Pharmaceutical Door Systems

Pharmaceutical process areas, food manufacturing and clean rooms have specific requirements that many door systems can not meet. Environmental control, cleanability with harsh chemicals and high tech automation are required to insure product quality and manufacturing efficiency. All Chase door systems are built with these requirements in mind. Chase doors are designed to comply with entrapment and egress codes as well as local and national building standards. Additional benefits include:

- Modular design with the latest technology, insuring that all door systems are both functional and cost effective.
- Features including flush panel construction, sloped track hoods, sloped or flush window frames and a concealed lower door guide system insure that all Chase pharmaceutical door systems are both beautiful and functional.
- A wide variety of panel finishes including stainless steel, fiberglass and Kydex.
- Pre-assembled, casing mounted drive systems for simplified field installation.



From walk-in coolers to large freezers and food processing facilities, ColdGuard® Cold Storage Doors combine the latest technology, materials and practical design features to meet the demanding requirements of the cold storage industry. Whether in a small restaurant, supermarket backroom or cold storage warehouse and distribution facility, all ColdGuard Doors incorporate a tough and thermally neutral fiberglass reinforced pultrusion (FRP) framework, molded plastic polymer casings and Non-CFC foamed-in-place polyurethane core. This innovative design produces a strong and durable door system that will provide years of worry-free service.



Swing Doors

Single or double panel ColdGuard Swing Doors provide simple, time-tested sealing and hinge systems for maximum performance in any application. Swing doors can be used on new applications, or to replace worn out OEM doors in walk-in coolers.

- Unique design allows Non-CFC foamed-in-place polyurethane insulation to lock in place with the fiberglass reinforced polymer (FRP) producing an extremely durable, insulated panel.
- Magnetic vinyl push-in gasket is standard on all ColdGuard Swing Doors.
- A variety of finishes are available including 26 gauge steel with USDA accepted white polyester finish, 26 gauge G-90 embossed galvanized steel, and galvalume, stainless steel, embossed white aluminum and smooth white aluminum.
- Self-lubricating cam lift hinges raise the door when opened, providing reduced friction on floor seal.
- Door panels are available in 4" and 6" panel thickness with an R Value of 32 and 48 respectively.
- Meets HR-6 Energy Independence and Security Act Requirements.
- A few options include, backup mirror image casings, jamb wall caps, thru-wall casings, keyed latch, door closer, casing mounted thermometer and light switch, and heat in door and casing. Other options are available please consult the factory.

Sliding Doors

Designed for high cycle, abusive applications, the ColdGuard horizontal sliding door is the workhorse of our product offering. We offer single and bi-parting doors for coolers and freezers in a variety of finishes. Rugged design using quality components is the key to the long life in a horizontal sliding door. Design features including a heavy duty FRP framework, heavy duty track system with permanently lubricated rollers and molded polymer casings make the ColdGuard the "best in class." All horizontal door systems can be manual or motor operated. Standard 4" and optional 6" panel thickness (for applications below -20°F.) are available.

- Utilizes the PerfectSeal™ Gasket System, a two-ply, fabric reinforced blade that provides an effective perimeter seal and eliminates troublesome bulb type seals used by competitors.
- Specially designed gusseted steel corner brackets are machined to perfectly fit inside the profile of the FRP pultrusions, providing exceptional frame strength and eliminating the need for aluminum, wood and PVC bracing.
- Unique design allows Non-CFC foamed-in-place polyurethane insulation to lock in place with the fiberglass reinforced polymer (FRP) producing an extremely durable, insulated panel.
- Maintenance free heavy duty extruded aluminum track rail.
- Please consult the factory for the many options available including the surface finish of stainless steel, aluminum, galvalume, or molded plastic polymer in white, gray or black.



Vertical Lift Doors

ColdGuard Vertical Lift Cold Storage Doors are an excellent choice for refrigerated docks, and applications with limited side room clearance. As with all ColdGuard doors, vertical lift doors utilize an FRP perimeter framework with internal reinforcement and foamed-in place construction. Vertical Lift Cold Storage doors offer superior insulation and sealing qualities over typical sectional garage doors. Vertical lift doors are available for cooler and freezer applications.

- Heavy duty door track has smooth "down and in" closing action for a positive perimeter seal.
- Standard torsion spring counterbalance system reduces side room requirements.
- Utilizes molded polymer framework – mirror casings available.
- Vision panels available.

Other Brochures from Chase

Are you interested in learning more about a specific product line from Chase? From Cold Storage Doors to Strip Doors to Corrosion Resistant Doors and many more, check out the product specific brochures that Chase has to offer and get all of the information you need. Available brochures are:

- Cold Storage Doors Brochure
- Corrosion Resistant Doors Brochure
- Roll-Up & Sliding Doors Brochure
- Insulated & Industrial Curtains Brochure
- Roll Goods Brochure
- Strip Door Brochure
- Fire & Industrial Sliding Door Brochure
- Pharmaceutical Doors Brochure



World's Leading Manufacturer of Specialty Doors

Chase Industries, Inc.
Cincinnati • Redmond
Toll-Free (800) 543-4455 • (513) 860-5565 • Fax (800) 245-7045
www.chasedoors.com • E-mail: info@chasedoors.com



Kydex® is a registered trademark of Klerdex

LEED® is a registered trademark of the U.S. Green Building Council®

In our continuing effort to improve our products, some specifications or descriptions may change. We reserve the right to make such changes without notice or recourse.

For downloadable drawings
and specifications please visit
www.chasedoors.com



Brochure #TB1115
Printed in the U.S.A.